



DELTA | XTEND™
REVERSE SHOULDER SYSTEM

Powered by Xperience



SURGICAL TECHNIQUE



Powered by Xperience

Cuff Tear Arthropathy (CTA) was described by Charles Neer in 1983¹ and has historically been seen as a significant surgical challenge.

Non-constrained total or hemi shoulder arthroplasties have poor clinical outcomes for such indications. The majority of constrained and semi-constrained prostheses developed in the 70's-80's for CTA (in particular all reversed ball and socket designs) remained purely experimental due to poor range of motion, instability and a high rate of glenoid loosening.^{2,6,16}

In 1985, Paul Grammont (Dijon University Hospital - France) designed the first semi-constrained reverse concept that met the challenges inherent in cuff tear arthropathy cases³ : Known today as the DePuy Delta CTA™ Reverse Shoulder, this shoulder prosthesis is now accepted as a treatment of choice for shoulder cuff tear arthropathy⁴, with more than 20 years of clinical success^{3,4,6} and 20 000 cases performed all over the world.

Based on the experience of the Delta CTA™ Reverse Shoulder, the next generation of implant evolved; the DePuy Delta Xtend™ Reverse Shoulder System. It has been designed using the latest scientific, engineering and clinical knowledge to maximise the clinical outcomes and enhance long-term survivorship in CTA cases by:

Respecting the three design features that differentiated the Delta CTA™ Reverse Shoulder from previous designs:

- Joint centre of rotation positioned on the glenoid surface to avoid pull-out torques on the glenoid component.⁵
- Non-anatomic neck-shaft angle (155°) for joint stability.^{3,6}
- Optimal Deltoid tensioning to maximise muscle action without over stretching the tissues.⁵

Reducing the risk of scapular neck erosion while maximising the shoulder range of motion:^{7,8}

- Inferior overlap of the glenoid component allowed by a new glenosphere design and metaglene fixation system.
- New high mobility humeral cup design.

Preserving bone for earlier intervention and faster recovery with:

- Curved back metaglene design⁹.
- Fluted modular humeral stem design based on 20 years of DePuy Global® anatomic shoulder history.⁹
- Modular eccentric epiphysis options for press-fit application.
- Thinner monobloc humeral stem for cemented application.

Based on the success of the Delta CTA™ Reverse Shoulder, the Delta Xtend™ Reverse Shoulder System is the next step forward for appropriate management of patients with cuff tear arthropathy. It is just one of the products within the DePuy shoulder portfolio that helps you treat your patient more effectively.

The Delta Xtend™ Reverse Shoulder System Surgeon Design Team



Dr Didier Capon
France



Dr David Collins
USA



Prof Anders
Ekelund
Sweden



Dr Laurent Lafosse
France



Prof Lieven
De Wilde
Belgium



Dr Cécile Nérot
France



Dr Ludwig
Seebauer
Germany



Dr Michael Wirth
USA

Delta Xtend™ Reverse Shoulder System Key Surgical Steps

Humeral Surgical Steps

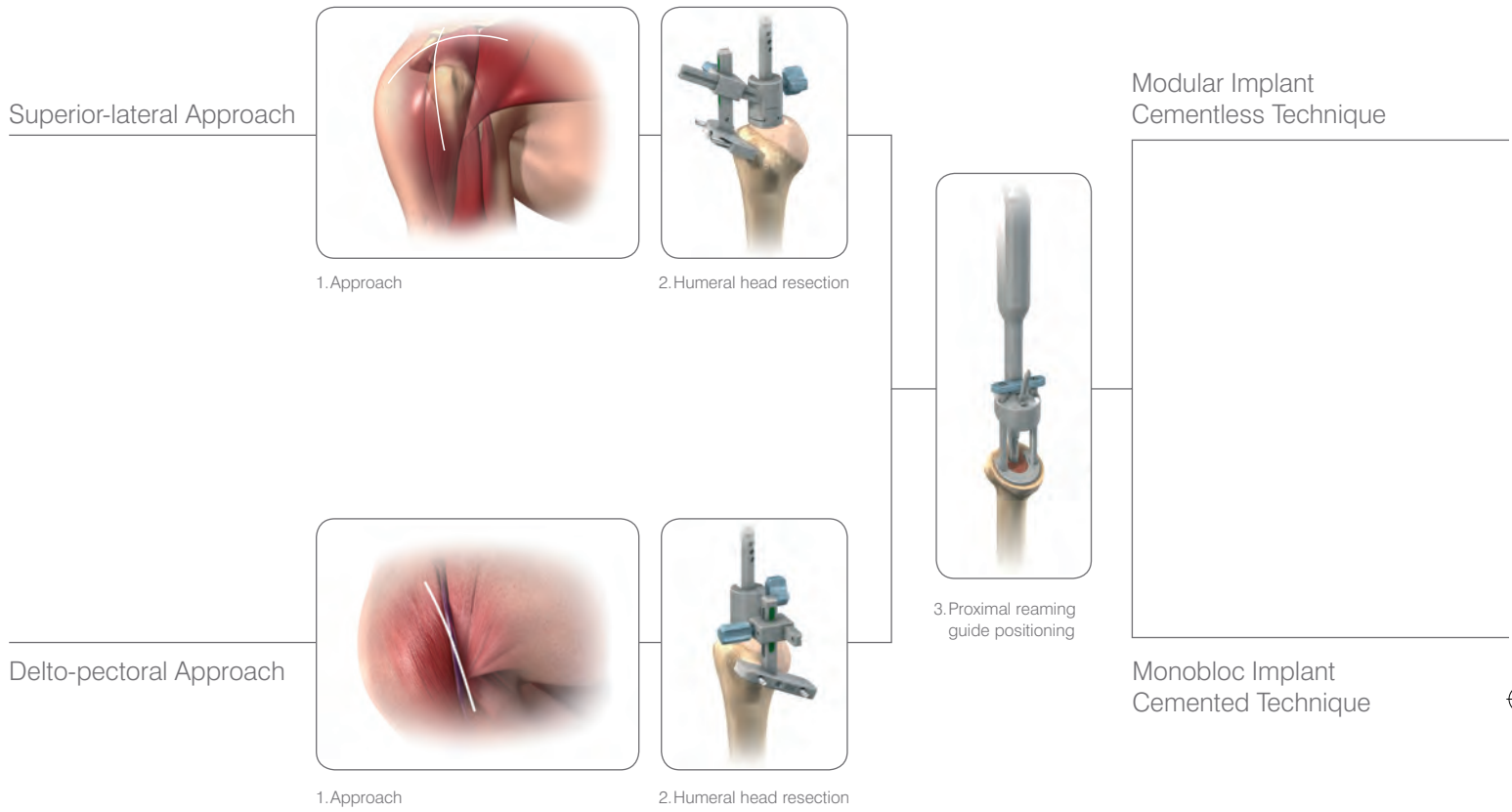

Glenoid Surgical Steps

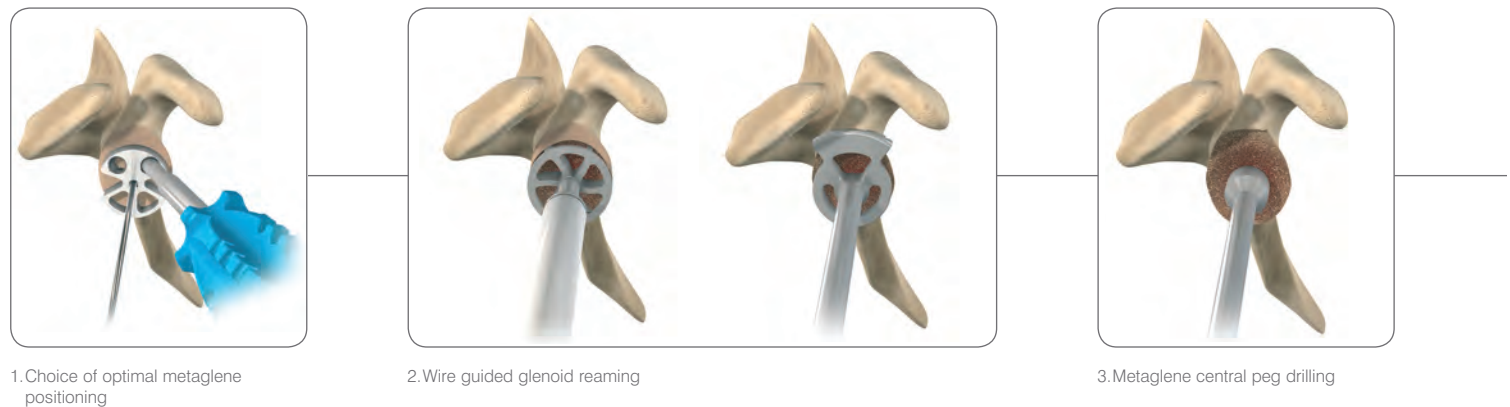

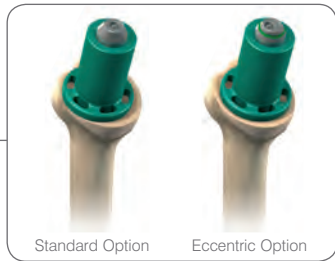

Standard Option Eccentric Option

4. Determination of the epiphysis size and eccentricity



5. Proximal humeral reaming



6. Diaphyseal broaching and angulation measurements



7. Epiphysis/diaphysis assembly

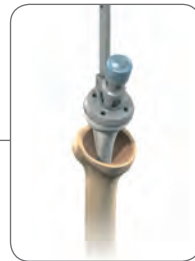

8. Final implant insertion



9. Cup impaction



4. Determination of the epiphysis size

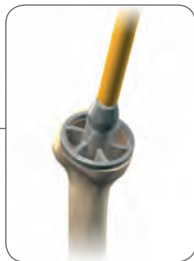

5. Proximal humeral reaming



6. Final implant insertion



7. Cup impaction

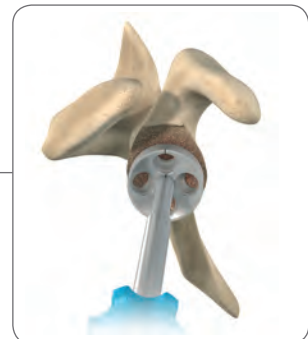

4. Metaglene impaction

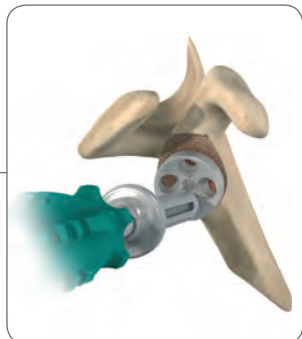

5. Inferior and superior locking screw insertion

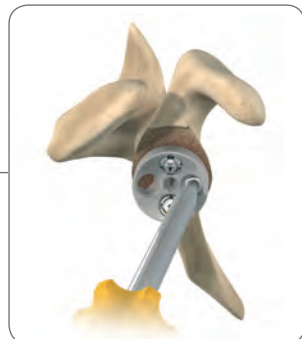

6. Anterior and posterior spherical head screw insertion



7. Glenosphere implantation





RECOVERY FUNCTION SURVIVORSHIP

DePuy believes in an approach to total shoulder replacement that places equal importance on recovery, function and survivorship.



Contents

Design Rationale

Delta Xtend™ Reverse Shoulder System Features	4
---	---

Surgical Technique

Pre-operative Templating and Patient Positioning	6
Surgical Approach	7
Intramedullary Canal Preparation	9
Humeral Head Resection	10
Exposing the Glenoid	14
Positioning the Metaglene	15
Reaming the Glenoid	18
Drilling the Central Hole	19
Metaglene Implantation	20
Inferior and Superior Metaglene Screw Placement	21
Anterior and Posterior Metaglene Screw Placement	24
Placement of the Proximal Humeral Reaming Guide	26

Cementless Modular Humeral Implants

Proximal Humeral Reaming	27
Distal Humeral Broaching	29
Humeral Trial Stem and Epiphysis Insertion	30

Cemented Monobloc Humeral Implants

Proximal Humeral Reaming	32
Humeral Trial Implant Insertion	33
Glenosphere Trial Placement	34
Cup Trials and Trial Reduction	35
Joint Tensioning and Stability Assessment	36
Definitive Glenosphere Fixation	37

Cementless Modular Humeral Implants

Definitive Humeral Implant Insertion	40
--------------------------------------	----

Cemented Monobloc Humeral Implants

Definitive Humeral Implant Insertion	42
Cases of Proximal Humeral Bone Loss	44
Revision to Hemi-Arthroplasty	46
Closure	47
Post-operative Management	47

Ordering Information

Implants	48
Instrumentation	49

Delta Xtend™ Reverse Shoulder System Features

The Delta Xtend™ Reverse Shoulder System is a total semi-constrained shoulder arthroplasty that reverses the normal biomechanics between the scapular and humeral components. It moves the gleno-humeral joint centre of rotation medially and inferiorly, increasing the deltoid lever arm and the deltoid tension. This allows the muscles of the deltoid group to compensate for rotator cuff deficiency.⁵ The Delta Xtend™ Reverse Shoulder System is comprised of two humeral stem types, providing the choice of press-fit or cemented fixation. The glenoid component is cementless with 4 screws as primary fixation and HA coating for secondary fixation.¹⁰ Each design feature has been defined to accelerate recovery, optimise function and maximise survivorship for the CTA patient treated by reverse shoulder arthroplasty.

Cementless Modular Stem

- 1 Hydroxyapatite (HA) coated titanium alloy **for optimal cementless fixation**⁹
- 2 Proximal filling stem design based on the anatomic DePuy Global® design - positioned in anatomic version **for optimal press-fit fixation**¹⁰

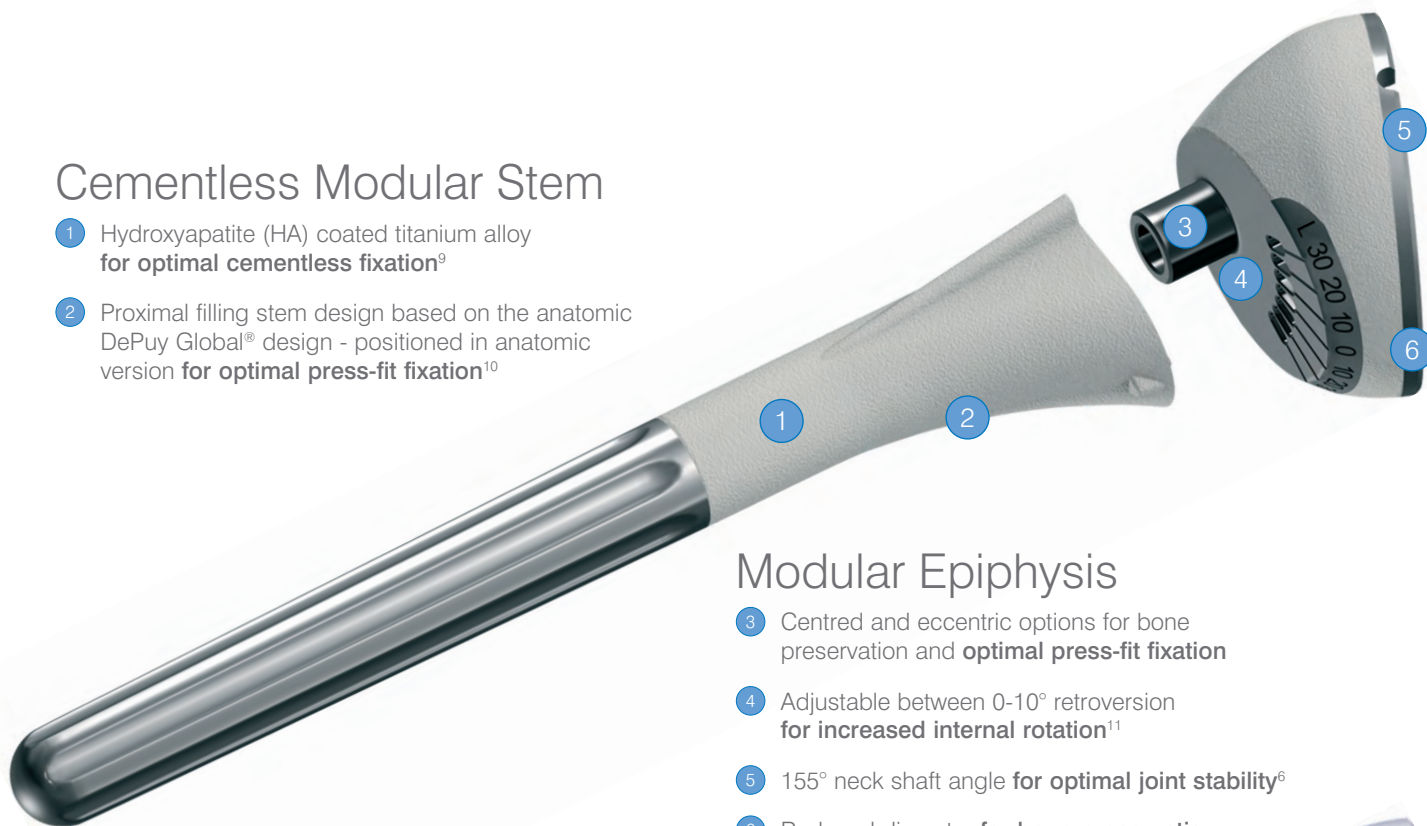

Modular Epiphysis

- 3 Centred and eccentric options for bone preservation and **optimal press-fit fixation**
- 4 Adjustable between 0-10° retroversion **for increased internal rotation**¹¹
- 5 155° neck shaft angle **for optimal joint stability**⁶
- 6 Reduced diameter **for bone preservation**

Cemented Monobloc Stem

- 7 Polished Cobalt Chromium alloy **for increased mechanical strength and optimised cemented fixation**¹²
- 8 Standard and long monobloc stems with suture hole fins and proximal height laser marking on the trial stem **for use in proximal bone loss cases**
- 9 Thin proximal area **for bone preservation**
- 10 155° neck shaft angle **for optimal joint stability**⁶

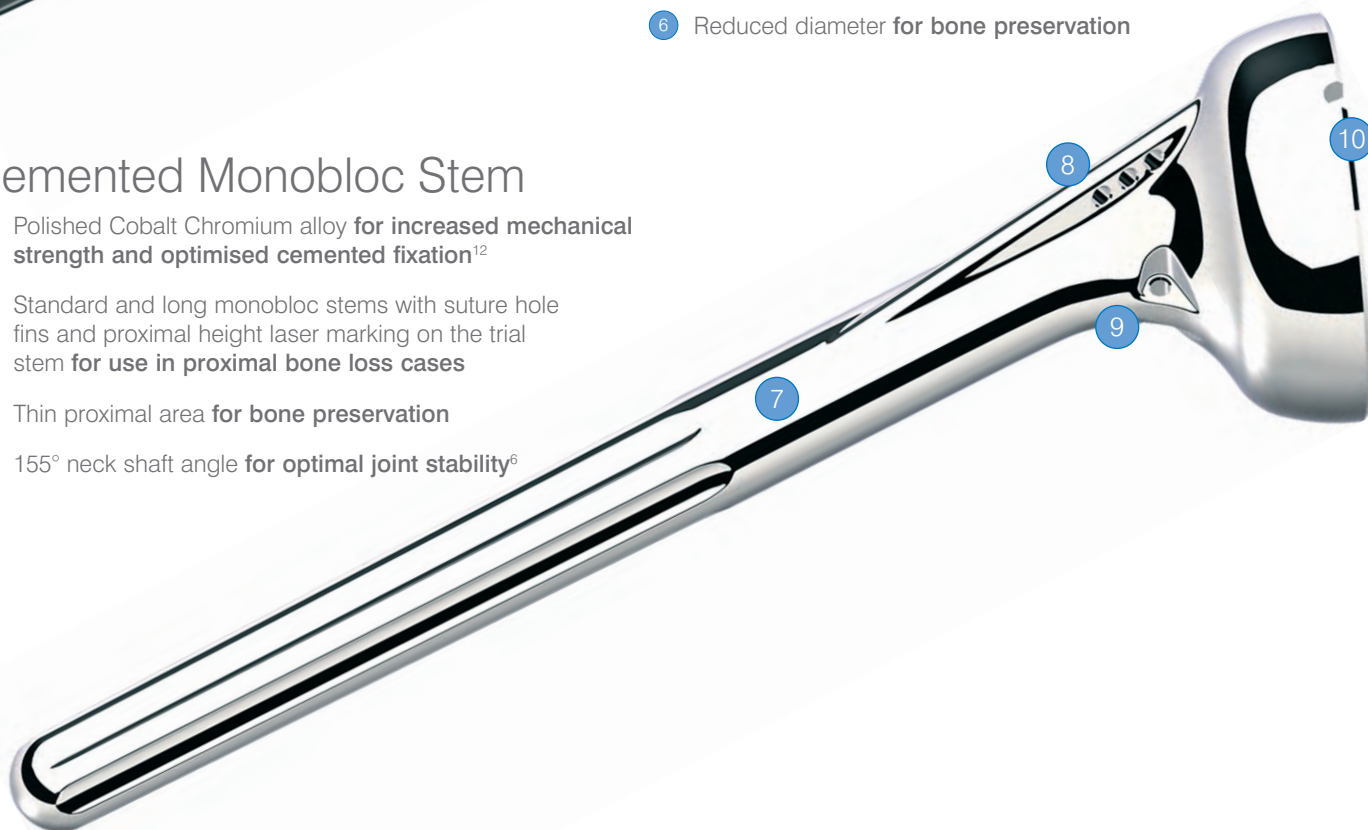



Polyethylene Humeral Cups

- 11 High mobility option for maximised range of motion & reduced risk of scapular erosion¹³
- 12 Three cup thicknesses to balance soft tissue for optimal deltoid tension based on clinical heritage⁴



Delta Xtend™ CTA Heads

- Hemi-heads available in 2 diameters and 2 thicknesses, for easy revision from reverse to hemi-arthroplasty if required
- Extended articular surface for articulation against acromion

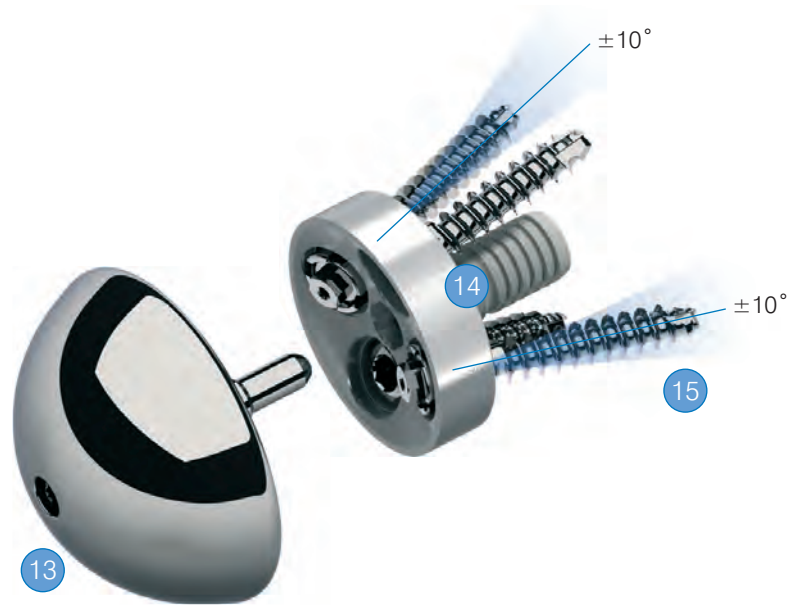

Glenoid Component

- 13 Increased glenosphere diameter (38 and 42 mm) and eccentric option for improved stability, maximised range of motion and reduced risk of scapular erosion⁹
- 14 Centre of rotation on glenoid surface for high resistance to loosening shear forces^{8,13}
- 15 Locking cannulated screws with adjustable angulation to enhance metaglene primary fixation and maximise resistance to loosening shear forces¹³
- 16 Curved back and smaller diameter metaglene, for bone preservation and low positioning on the glenoid to reduce risk of scapular bone erosion^{8,13}



Pre-Operative Templating & Patient Positioning

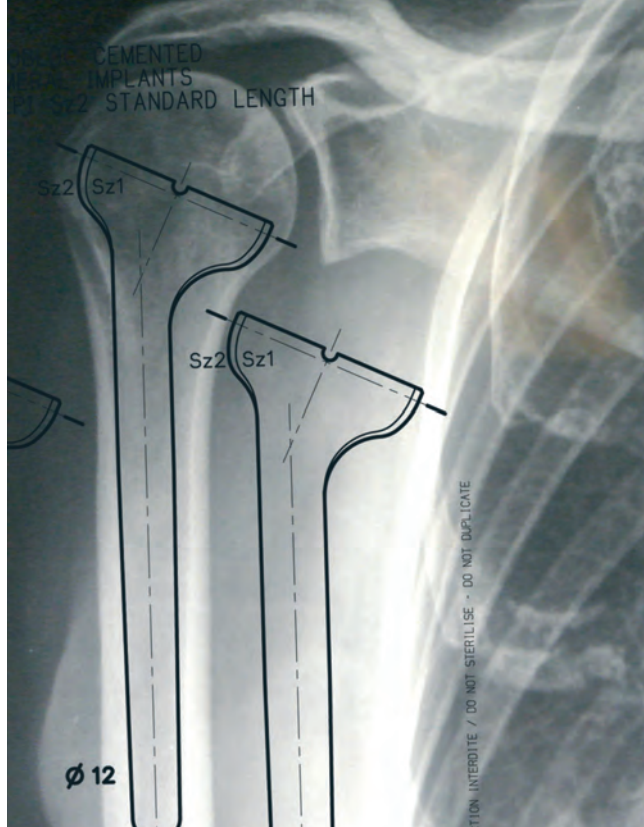

Figure 1

Pre-operative Templating

An initial assessment of the glenoid should be carried out using radiographic and CT imaging to determine whether the patient is suitable for treatment. The size of the glenoid vault should be assessed to ensure that all four metaglene screws can be placed within glenoid bone.

Pre-operative planning should also be carried out using AP and lateral shoulder radiographs of known magnification and the available template to help the surgeon determine the size and alignment of the implant (Figure 1). The final decision should be taken in the operating room, during surgery.



Figure 2



Figure 3

Patient Positioning

The patient should be in the beach chair position, with the affected arm completely free (Figures 2 and 3).

Surgical Approach: Superior-lateral

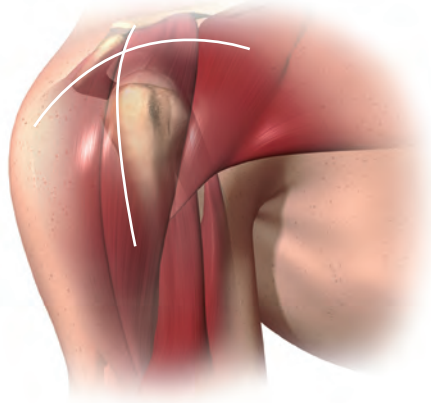

Figure 4

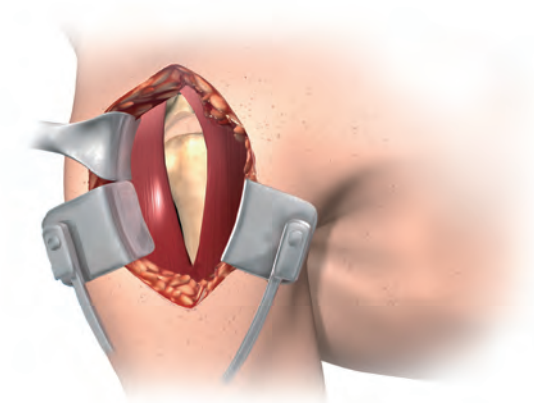

Figure 5

The Delta Xtend™ Reverse Shoulder System prosthesis can be implanted using a superior-lateral deltoid split approach or a delto-pectoral approach. The choice depends on the surgeon's preference and clinical parameters.

The delto-pectoral approach has the advantage of offering an enhanced view of the inferior part of the glenoid. Revision surgery is usually performed using a delto-pectoral approach so the approach can be made through the original scar and it allows for a longer humeral incision when faced with difficult removal of the humeral stem.

Alternatively, the superior-lateral approach enables clear visualisation of the glenoid and therefore facilitates the implantation of the glenoid components of the prosthesis, in particular where the glenoid is retroverted. Moreover, this approach does not necessitate the partial detachment of the subscapularis muscle that could be seen as further weakening of the remaining cuff structure.

Superior-lateral Approach

The skin incision is 10-12 cm and can be antero-posterior along the lateral edge of the acromion or made in a lateral direction (Figure 4). Following subcutaneous dissection, separate the anterior and middle deltoid muscle bundles opposite the lateral margin of the acromion using blunt dissection (Figure 5). The dissection starts at the level of the AC joint, 5-7 mm posterior to the tip of the acromion and extends straight

laterally down into the deltoid muscle. It should not extend more than 4 cm from the external aspect of the acromion in order to preserve the axillary nerve which is located below the turning fold of the subacromial bursa.¹⁴

When the subacromial bursa is visible, gentle longitudinal traction in line with the limb allows a retractor to be placed in the subacromial space. The anterior deltoid is then released subperiostally from its acromial insertion up to the AC joint. The deltoid release from the anterior acromion can include a small piece of bone to facilitate repair and to protect the deltoid muscle.

Once the subacromial bursa has been removed, the humeral head is visible at the anterior edge of the acromion. Exposure may be improved, if necessary, by dividing the AC ligament and performing acromioplasty.

The limb is then externally rotated and the head is dislocated antero-superiorly to facilitate positioning of the cutting guide. If the bicep is still present, a tenotomy or tenodesis should be performed. The subscapularis, teres minor and infraspinatus are retained when present. A partial detachment of the subscapularis may be performed when the superior dislocation of the humerus is difficult to obtain.

Surgical Approach: Delto-pectoral

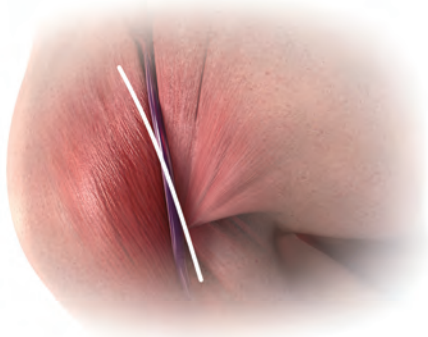

Figure 6

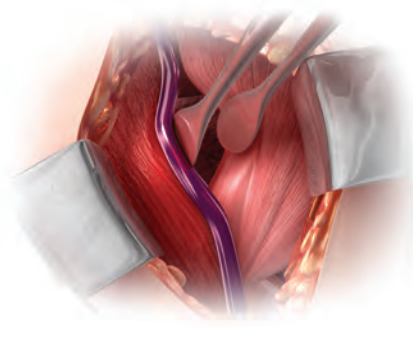

Figure 7

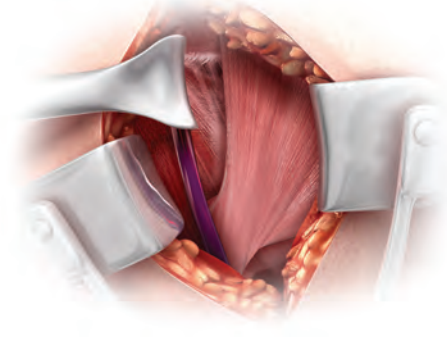

Figure 8

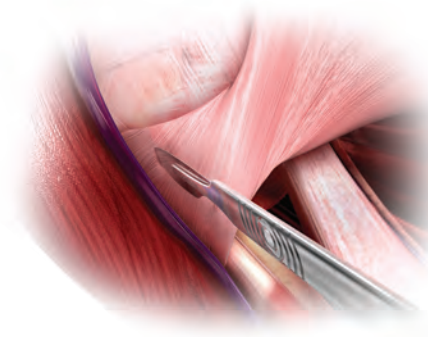

Figure 9

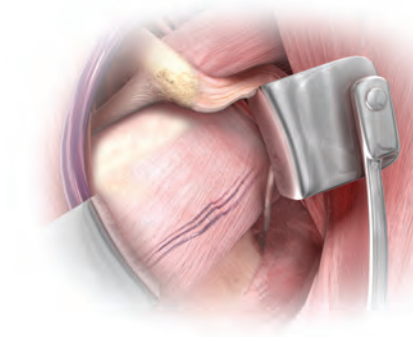

Figure 10

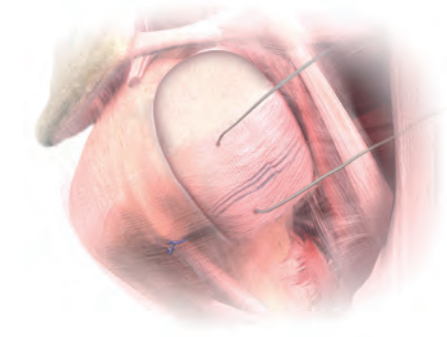

Figure 11

Delto-pectoral Approach

The skin incision follows a line from the midpoint of the clavicle to the midpoint of the arm (Figure 6). Subcutaneous flaps are elevated to expose the fatty strip that demarcates the delto-pectoral interval (Figure 7). Dissect medial to the cephalic vein and retract it laterally with the deltoid muscle (Figure 8). Incise the clavipectoral fascia from the inferior border of the coracoacromial ligament distally to the superior border of the tendon of the sternal head of the pectoralis major (Figure 9). Dissect the humeroscapular motion interface (subacromial, subdeltoid and subcoracoid). Palpate the axillary nerve at the anterior-inferior border of the subscapularis muscle (Figure 10). Electrocoagulate or ligate the anterior humeral circumflex vessels (“three sisters”) near the humerus at the inferior border of the subscapularis.

Place a tag suture in the tendon of the subscapularis (Figure 11), 2 cm medial to its point of insertion, in the lesser tuberosity. Release the tendon, along with the underlying capsule, from the lesser tuberosity and the proximal humerus.

Ascertain the integrity of the biceps long head tendon. If still present, tenodesis it in the groove or to the pectoralis major tendon, or proceed with a tenotomy for elderly patients.

If necessary strip the remaining inferior and posterior-inferior capsule from the humerus. Dislocate the humeral head.

Intramedullary Canal Preparation

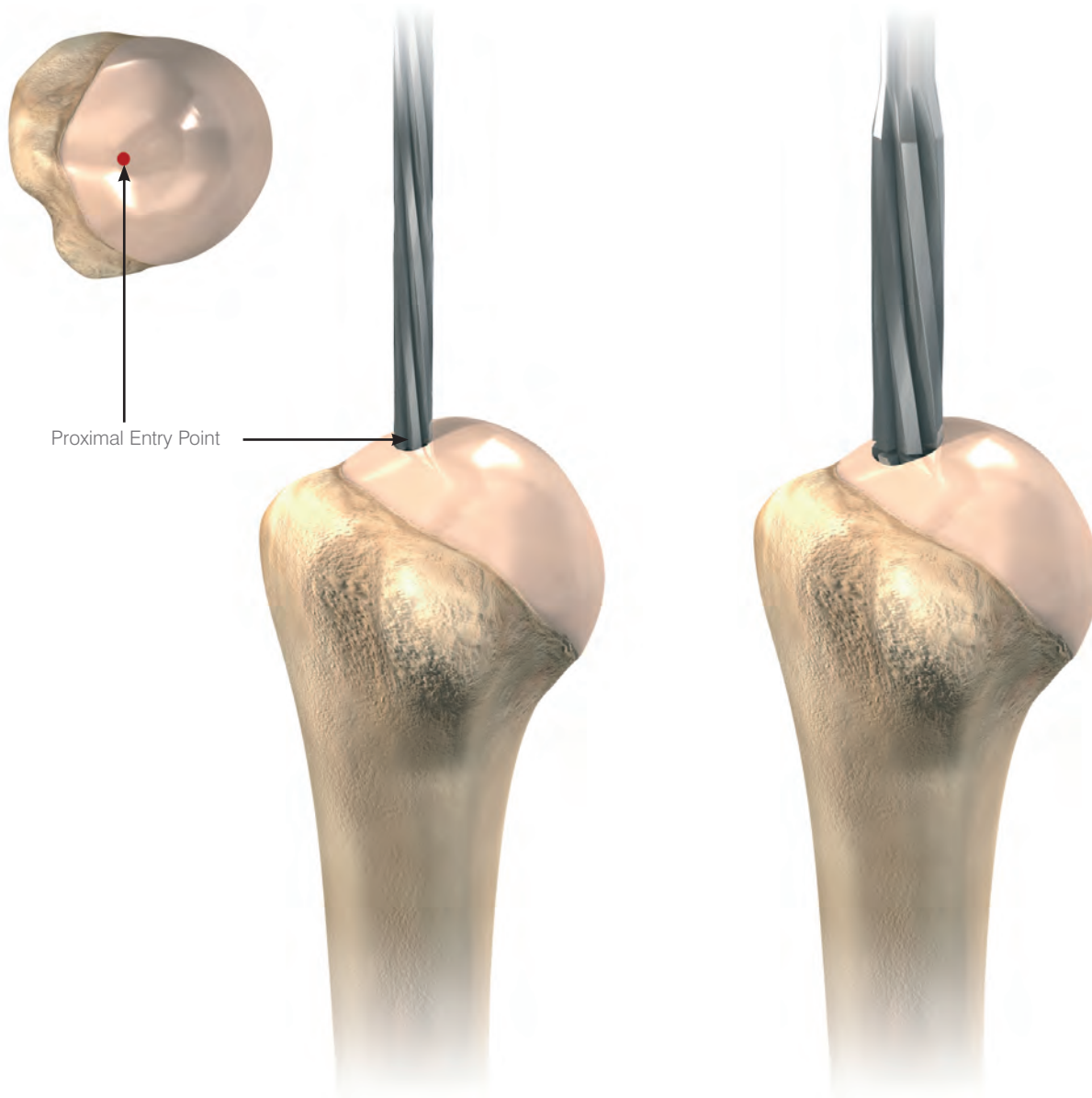

Figure 12

Figure 13

Using the 6 mm medullary canal reamer, make a pilot hole in the humeral head, so that the reamer passes directly down the axis of the intramedullary canal (Figure 12). Hand ream the medullary canal using the T-handle on the reamer. **Do not use a power reamer since this could damage the humerus.**

When using the standard length prosthesis, pass the reamer down the intramedullary canal until the mid-level circular mark on the reamer is level with the pilot hole. When using the long stem prosthesis, pass the entire length of the cutting flutes down the intramedullary canal.

Sequentially ream, increasing the diameter until there is contact with cortical bone of the intramedullary canal of the humerus (Figure 13).

The final reamer size chosen will determine the size of the cutting guide handle, the epiphyseal reaming guide, the broach, trial stem and final implant. For example, if the 12 mm reamer begins to gain purchase in the intramedullary cortical bone, use a 12 mm humeral trial stem and final component, both for cemented and cementless humeral implant versions.



Humeral Head Resection

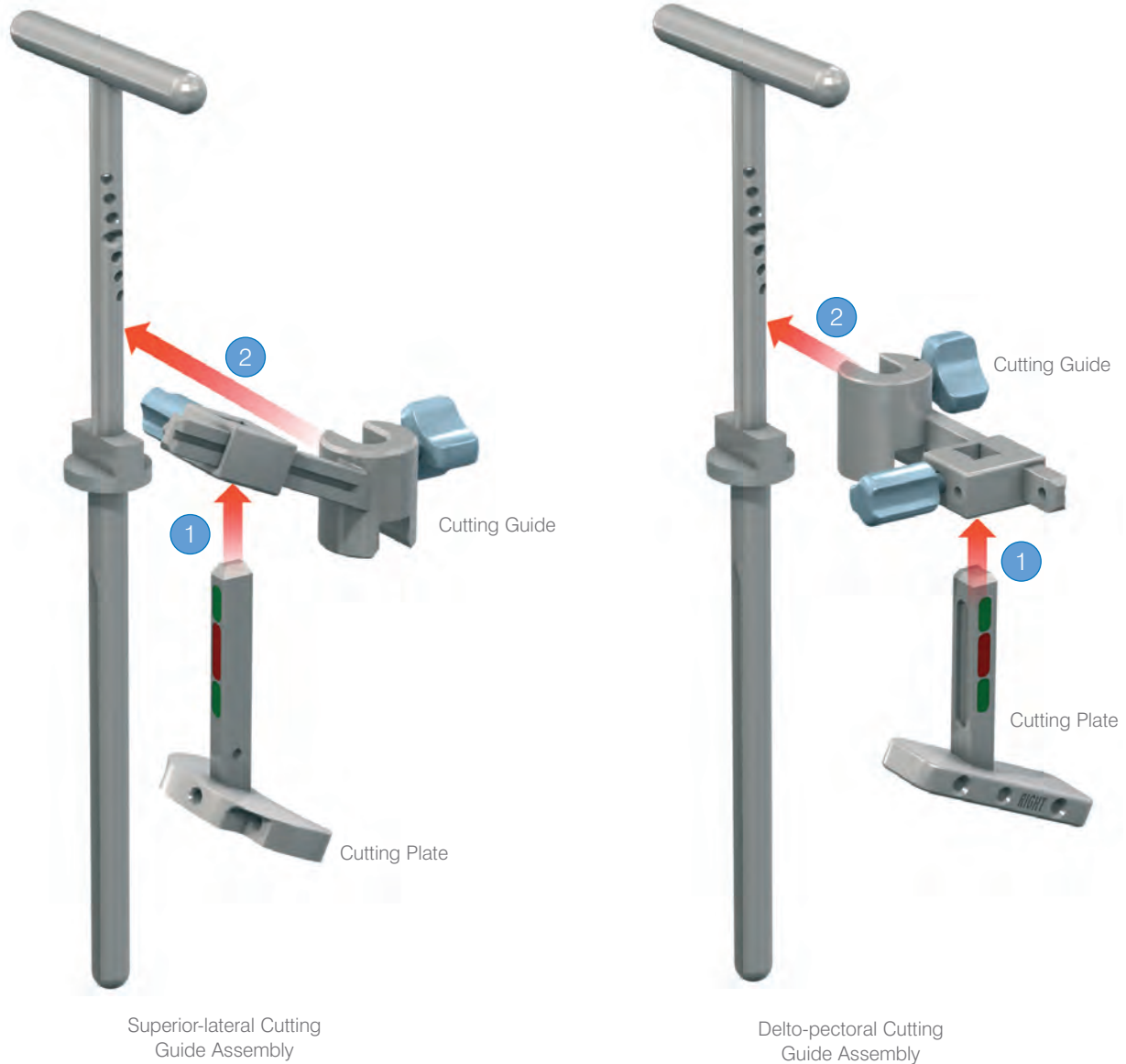

Figure 14

Select the appropriately sized cutting guide handle. Taking the previous example, if reaming stopped at 12 mm, select the 12 mm handle. Select the cutting guide and cutting plate according to the surgical approach used: superior-lateral or delto-pectoral.

Assemble the cutting plate on the cutting guide first ① and then fix the cutting guide onto the cutting guide handle ② (Figure 14). The cutting guide should be fully seated on the cutting handle.



Humeral Head Resection

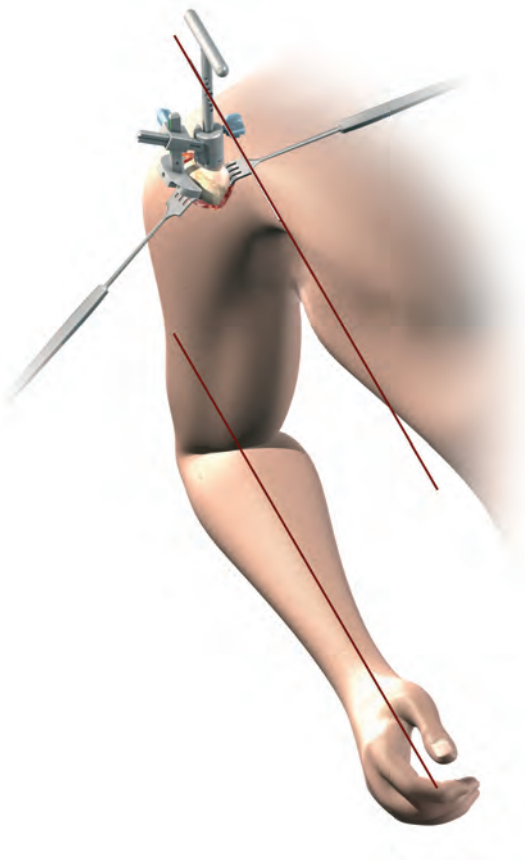

Figure 15

Drive the cutting assembly down the intramedullary canal until full contact with the superior humeral head is obtained.

Insert the orientation pin through the hole in the cutting handle, to achieve desired retroversion. The retroversion is calculated with reference to the forearm axis. This should preferably be close to 0-10° since excessive retroversion can restrict joint motion, especially internal rotation. However care should be taken not to damage the subscapularis insertion by resecting the head with excessive anteversion. The cutting handle should then be rotated to align the orientation pin and the forearm (Figure 15).

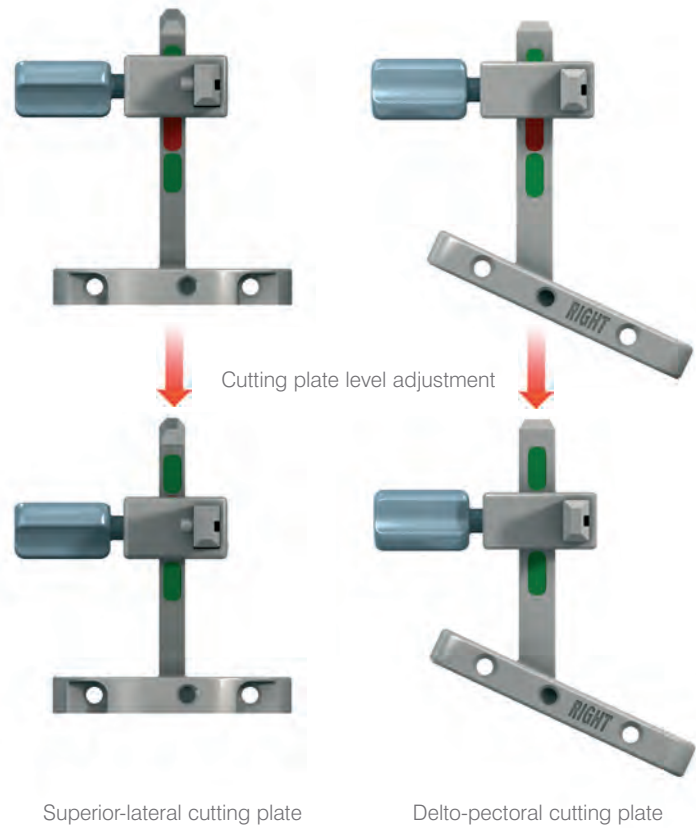
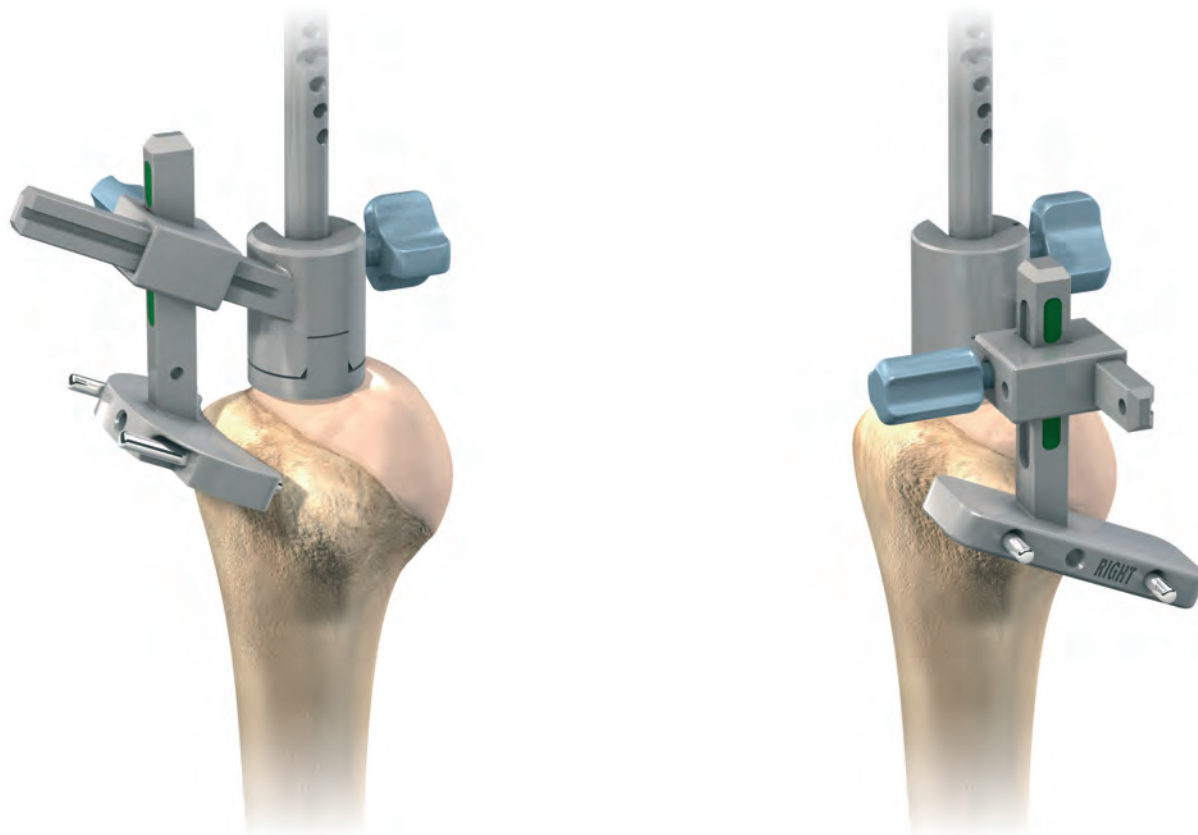

Figure 16

Slide the cutting plate to adjust the cutting level. The cutting plate colour code indicates the appropriate resection level. If the cutting level indicator is green, the guide is at the correct height. If it is red, the cutting plate needs to be adjusted (Figure 16).

Humeral Head Resection



Superior-lateral approach

Delto-pectoral approach

Figure 17

Following the colour code guidance, the surgeon should resect 1 - 2 mm of the proximal area of the greater tuberosity (at the level of the supraspinatus insertion in an intact shoulder).

Pre-drill the cortical bone through the cutting plate using a 3.2 mm drill bit, and insert the two fixation pins to fix the cutting plate to the humerus (Figure 17).

Note: the cutting angle is 155°, and therefore different from the anatomical neck/shaft angle of 135°. 155° is recommended for reverse shoulder systems.⁶



Humeral Head Resection

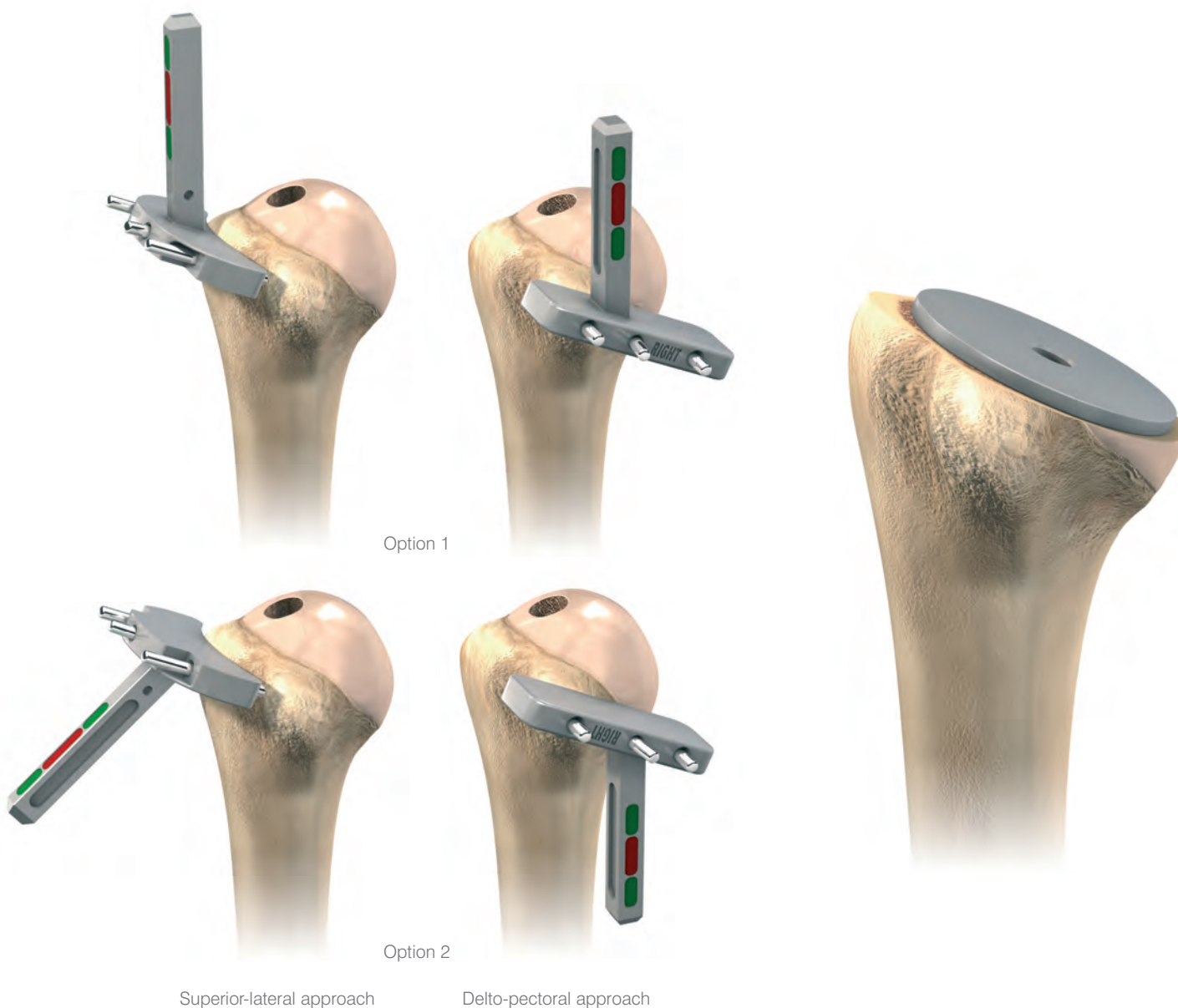

Figure 18

Figure 19

Remove the cutting guide assembly, add a third (divergent) fixation pin through the middle hole of the cutting plate to secure the assembly. Resect the humeral head, aligning the saw blade with the superior aspect of the cutting plate (Figure 18, Option 1).

Note: the two external pins are parallel, this enables the cutting plate to be reversed before being secured with the third divergent fixation pin, providing a flat cutting surface (Figure 18, Option 2).

Place the humeral resection protecting plate onto the resected surface to protect the bone from damage during the following surgical steps (Figure 19).

Pass a forked retractor under the scapula to lower the humerus. If this provides a clear sight of the glenoid surface, the resection level is correct. If not, a further resection may be required.



Exposing the Glenoid

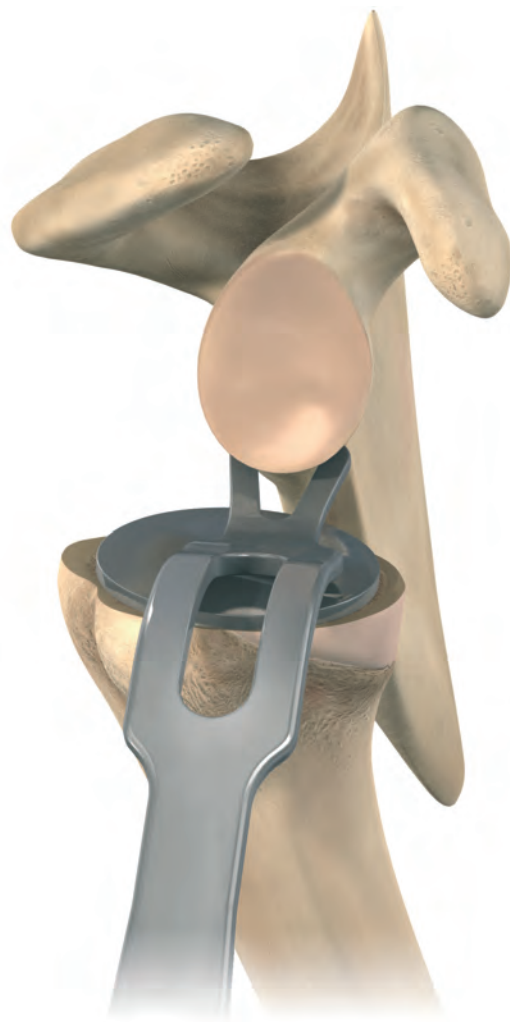

Figure 20

The forked retractor should be placed under the inferior glenoid labrum to move the humerus distally or posteriorly, depending on the approach taken (Figure 20).

When exposing the glenoid, it is critical to note the presence of the axillary nerve and protect it at all times. Excise the biceps remnant and entire labrum. Release the entire capsule from around the glenoid. In certain cases, the capsule may have to be excised depending on the extent of any contractures and the adequacy of exposure. Also, the origin of the triceps long head may be incised from the infraglenoid tubercle. Bluntly (finger or elevator) dissect in a circumferential manner from the base of the coracoid process to well beyond the most inferior aspect of the glenoid.

It is essential to palpate the following bony scapular orientation points: the base of the coracoid process, the inferior part of the glenoid neck and when possible, infraglenoid tubercle and lateral border of the scapula. Retractors should be placed so that the entire glenoid face is in clear view to aid accurate placement of the guide pin.

Glenoid Preparation

Remove any remnants of labrum from the glenoid. Then remove all articular cartilage from the glenoid face using a large straight curette. In addition, any osteophytes present may also have to be removed to determine the bony anatomy.

Positioning the Metaglene

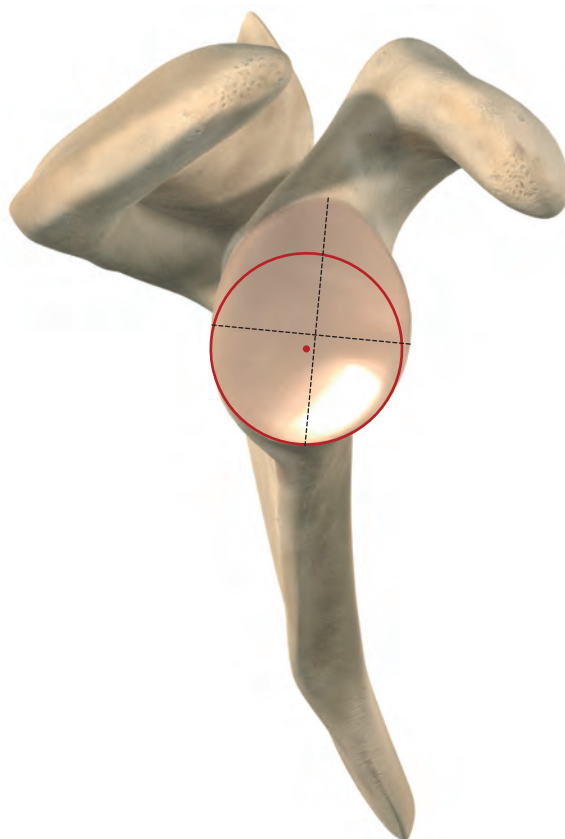

Figure 21

Particular attention should be given to metaglene positioning to achieve optimal glenoid fixation, range of motion and limit potential bone impingement.

The position must be chosen to obtain maximum contact with the glenoid surface and to allow secure fixation of the screws in bone.

To obtain good bone seating, the metaglene should ideally be positioned on the inferior circular area of the glenoid. The metaglene central peg should be positioned in the centre of the inferior circle of the glenoid (This point is often posterior and inferior to the intersection of the glenoid axes) (Figure 21).

Using these anatomical reference points helps to position the metaglene as inferior as possible on the glenoid in order to limit potential bone impingement, while keeping a secure glenoid implant fixation. However, radiographic, CT images combined with X-ray templates and the intra-operative view may indicate a slightly more superior position, to obtain fixation in good bone stock and complete sitting of the metaglene on the bone.

Positioning the Metaglene



Figure 22

The metaglene positioner is used to determine the optimal metaglene position. The positioner plate is the same diameter as the metaglene.

Assemble the positioner by inserting and screwing the internal rod into the positioner handle (Figure 22).

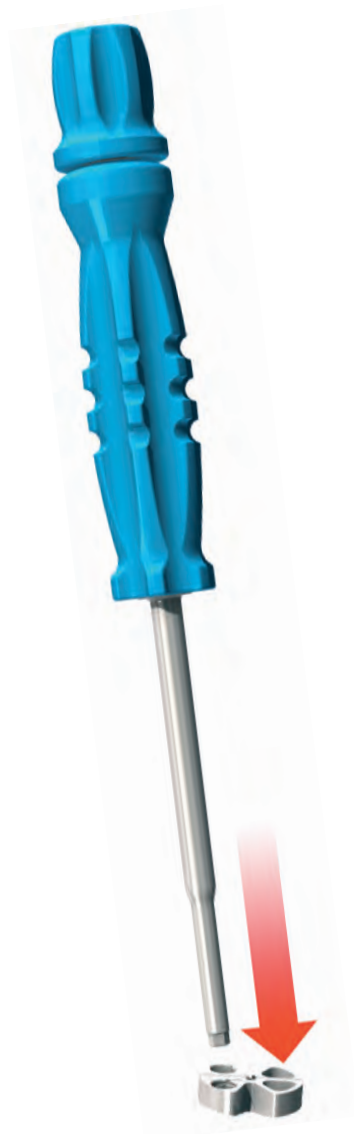

Figure 23

Then insert the hex head tip of the handle into the corresponding plate hole (right or left depending on the shoulder being operated upon) (Figure 23) and lock the assembly by screwing the internal rod tight (Figure 24).



Figure 24

Note: the handle is set at an angle of 20° to the plate to ensure optimal visibility (Figure 24).

Positioning the Metaglene

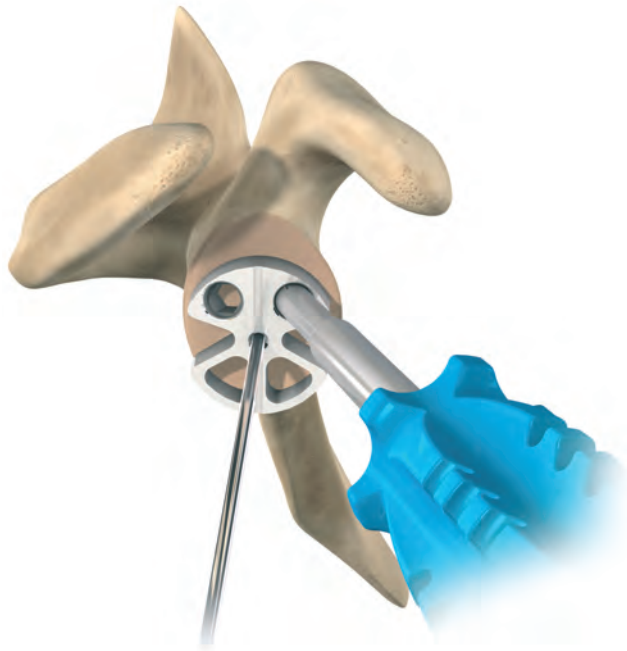

Figure 25

Position the plate as inferiorly as possible so that its border follows the inferior edge of the glenoid. Note that inferior osteophytes may result in mal-positioning. X-rays should therefore be checked to avoid this problem.

Providing the morphology of the glenoid has not been altered by disease, the guide plate is oriented perpendicularly to the plane of the glenoid face. Ensure that the proximal handle of the instrument is not tilted superiorly. The guide pin should be inserted either perpendicularly to the glenoid face or with a slight superior direction. This ensures that the glenosphere will either be perpendicular or with a slight inferior tilt which may reduce the risk of scapular notching.

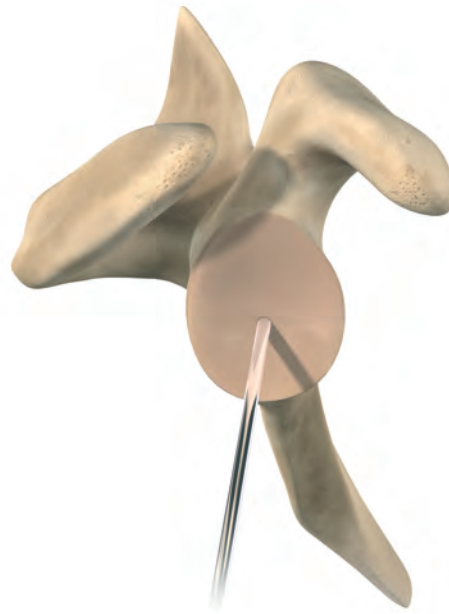

Figure 26

Place the 2.5 mm metaglene central guide pin in the plate central hole and drive it 3 - 4 cm through the glenoid using a power tool (Figure 25).

Remove the metaglene positioner, leaving the guide pin in place (Figure 26).

Reaming the Glenoid

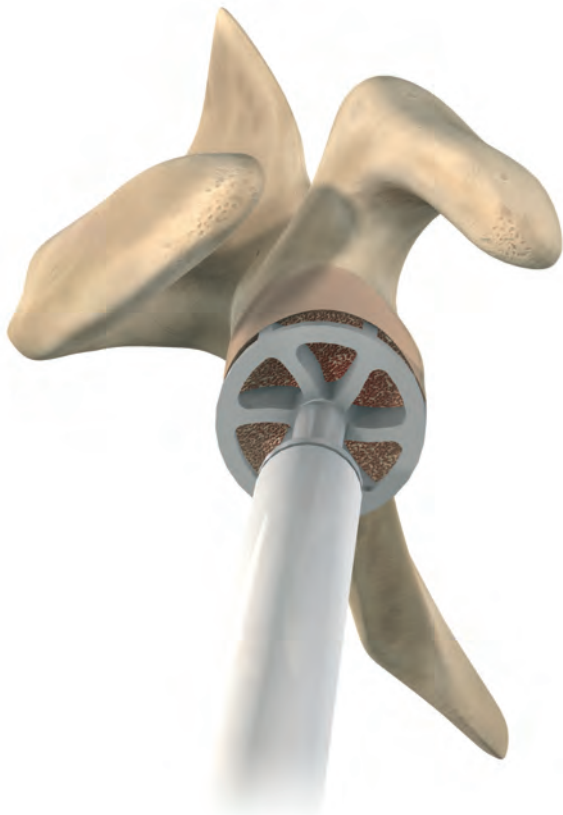

Figure 27

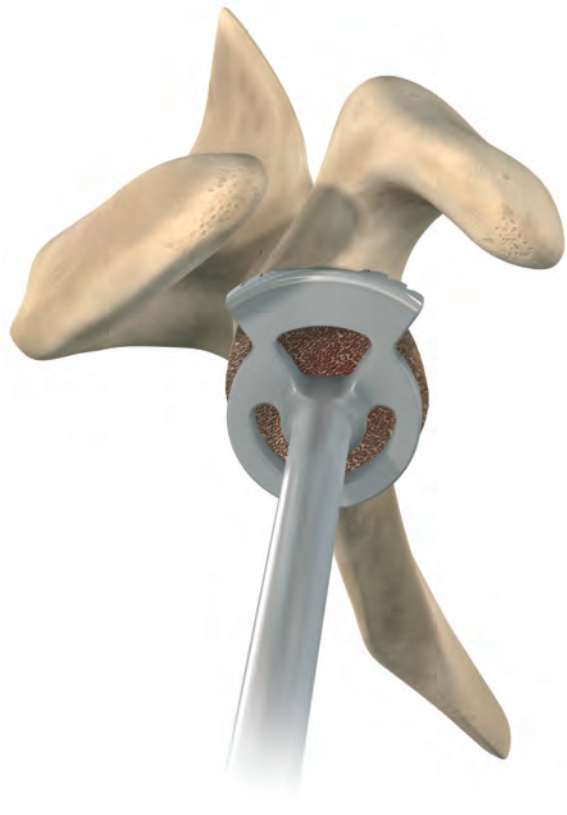

Figure 28

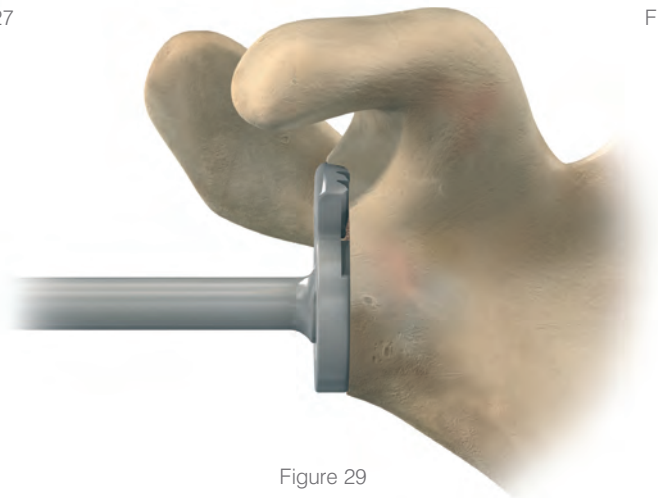

Figure 29

Slide the 27 mm glenoid resurfacing reamer onto the central guide pin and carry out the reaming using a power tool. This reamer prepares a smooth curved surface with the same diameter as the metaglene (Figure 27). Use the metaglene reamer carefully to avoid any fracturing of the glenoid, especially if the glenoid is sclerotic. Start the reaming, turning at low speed prior to engaging the glenoid. It is useful to collect the bony products of reaming for possible grafting. Irrigate frequently to maximise visualisation and thereby ensure optimal reaming. Preserve the subchondral bone.

Ream the upper area of the glenoid by hand, using the manual 42 mm glenoid reamer (Figure 28). This step is necessary to avoid any potential conflict between the glenosphere and the superior area of the glenoid (Figure 29).

Manual reaming should be carried out until the central part of the manual reamer is in full contact with the curved central glenoid surface.

Drilling the Central Hole



Figure 30

Use the same manual glenoid reamer to also ream the glenoid anteriorly, posteriorly and inferiorly if necessary. A smooth surface without any remaining cartilage should be obtained.

Check the adequacy of reaming by applying the glenoid reaming level checker to the glenoid surface. No space should be seen between the instrument and the glenoid surface unless this is due to bone erosion (Figure 30).

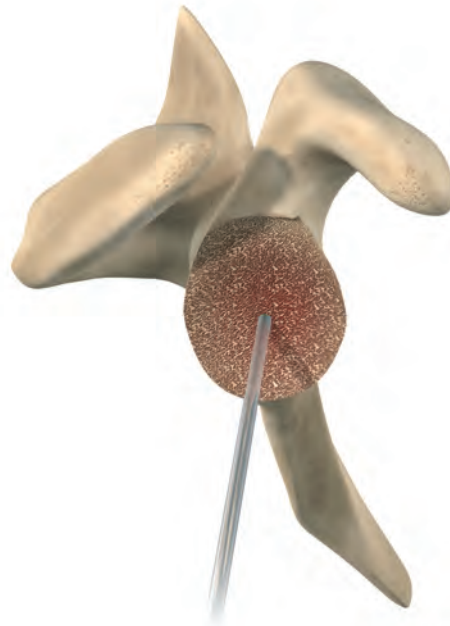

Figure 31



Figure 32

Remove the resurfacing reamer, leaving the metaglene central guide pin in place (Figure 31).

Connect the cannulated stop drill to the power tool and drill the central hole over the guide pin until full contact between the drill and bone is obtained (Figure 32).

Remove the stop drill and the central guide pin.

Metaglene Implantation



Figure 33

Assemble the internal rod of the metaglene holder in the metaglene holder main body. Insert the metaglene holder hex tip in the final metaglene implant central hole. Lock the assembly by screwing the internal rod tight (Figure 33).

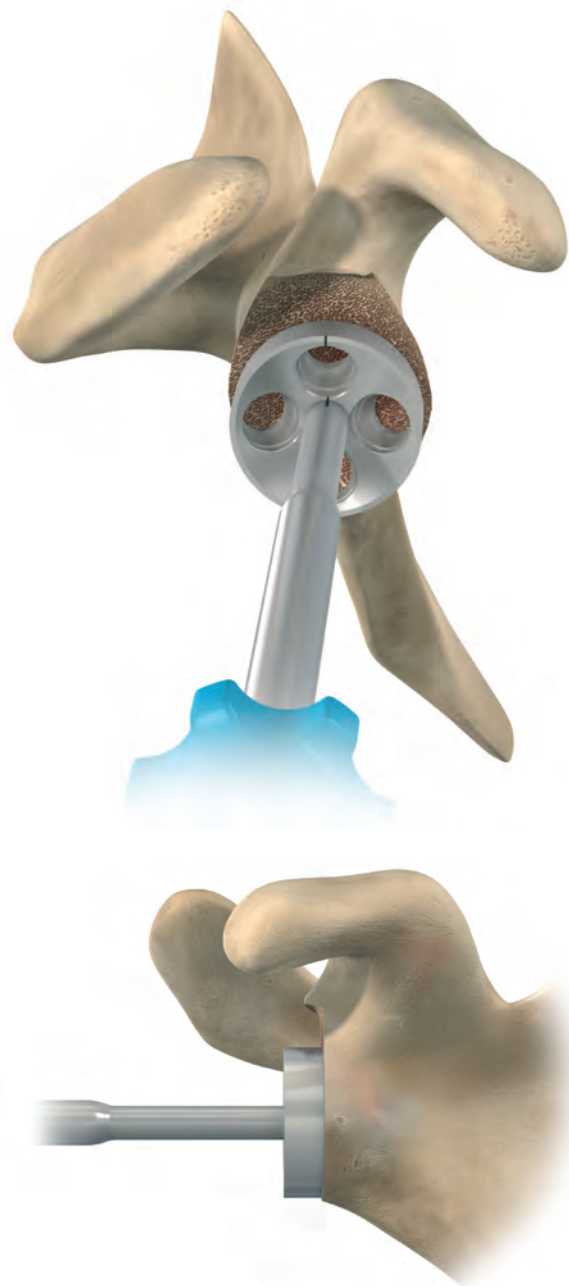
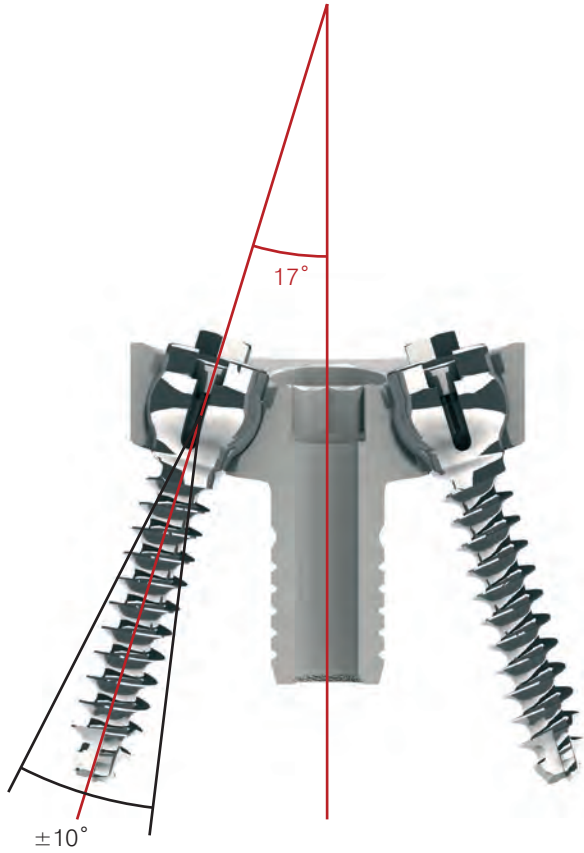

Figure 34

Place the metaglene on the glenoid and ensure that the metaglene is fully seated on bone. Apply bone graft if necessary to help fill any surface irregularities between the metaglene and the glenoid bone. Identify the rotational orientation that enables the inferior screw to be contained within the inferior pillar of the scapula. Check that the vertical metaglene marking is aligned with the scapular pillar inferiorly and with the coracoid process base superiorly (long axis of the glenoid) (Figure 34). The metaglene peg is slightly oversized to enable a press fit. Gently impact with light mallet blows in the proper orientation for inferior screw placement and remove the metaglene holder.

Inferior and Superior Metaglene Screw Placement



Metaglene Superior-Inferior Cross Section
Polyaxial Locking Screws

Figure 35

Locking metaglene screws allow an angulation of $\pm 10^\circ$ around the optimal 17° screw positioning³ (Figure 35). Locking screws must be used for the inferior and superior holes.

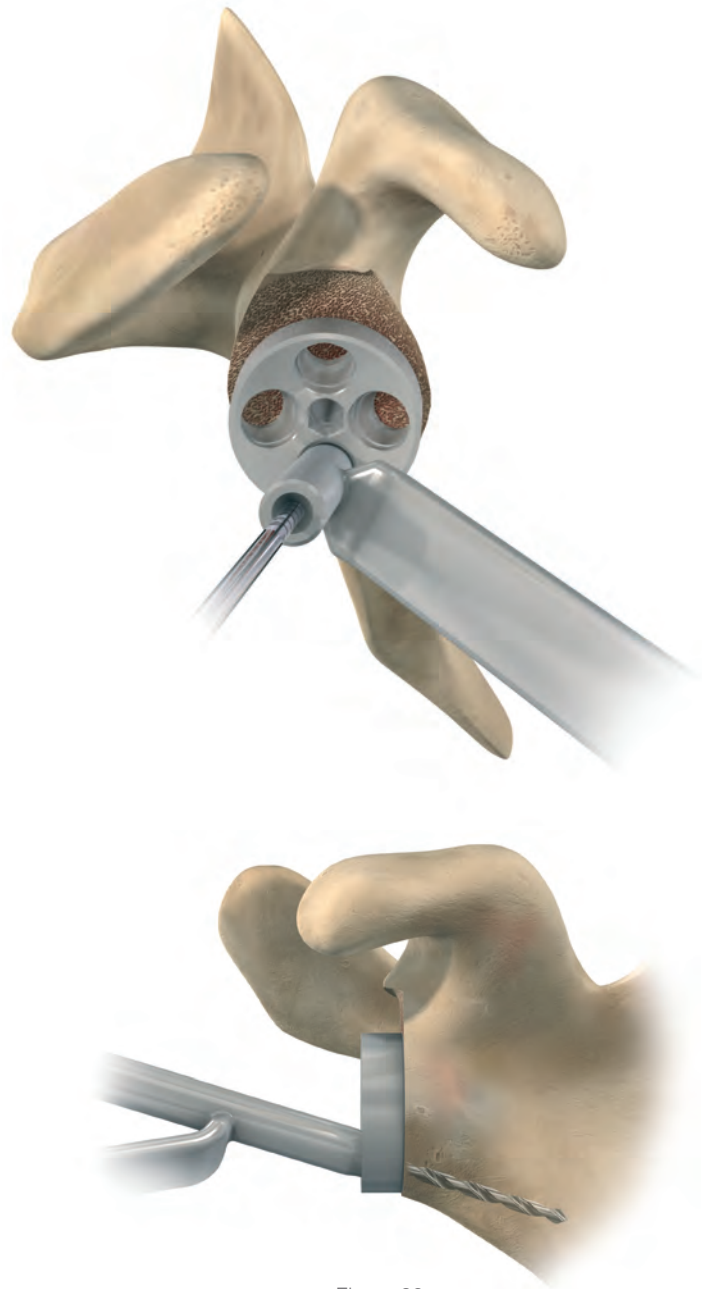

Figure 36

Hold the 2.5 mm drill guide against the inferior metaglene hole. The drill guide can be angled to $\pm 10^\circ$ but should always be seated fully on the metaglene hole. Palpate the bony pillar and direct into good bone. Using the 2.5 mm drill bit, start drilling through the subchondral bone to about 10 to 12 mm depth (Figure 36). Then stop drilling and push gently on the drill bit to make sure that the drill is seated in bone. Redirect and re-drill to locate bone stock if necessary.

Inferior and Superior Metaglene Screw Placement



Figure 37

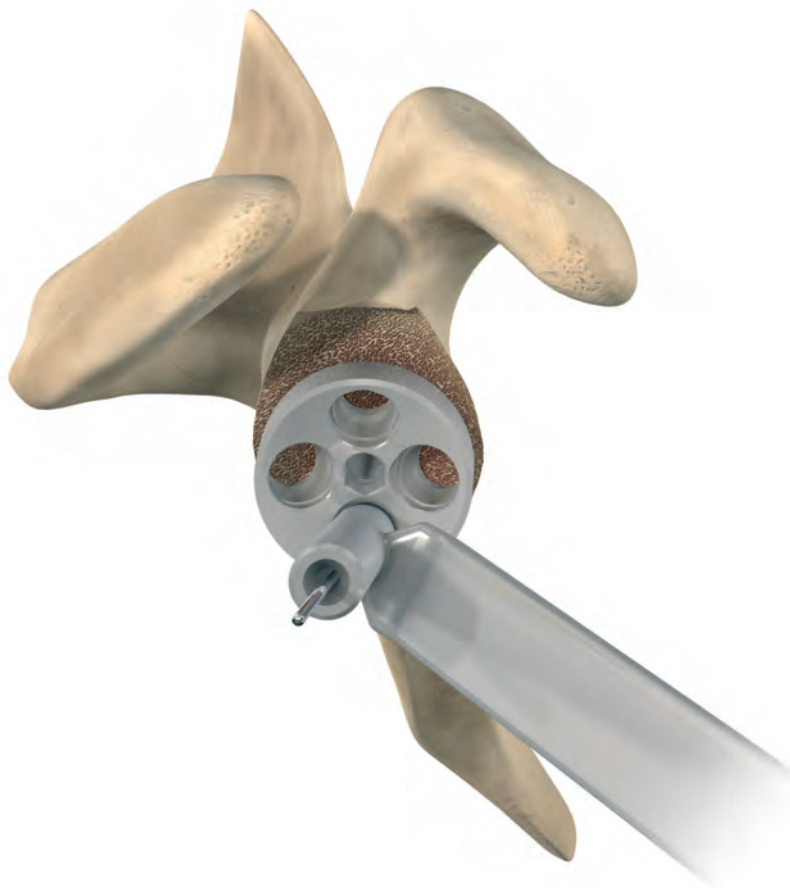

Figure 38

The goal is to have a sufficiently long screw inferiorly, usually 36 mm or more. The length for the screw is indicated on the drill bit by laser markings (Figure 37). When necessary, the screw depth gauge can also be used to obtain optimal screw length.

Insert the 1.2 mm guide pin through the drill guide and then remove the drill guide (Figure 38).

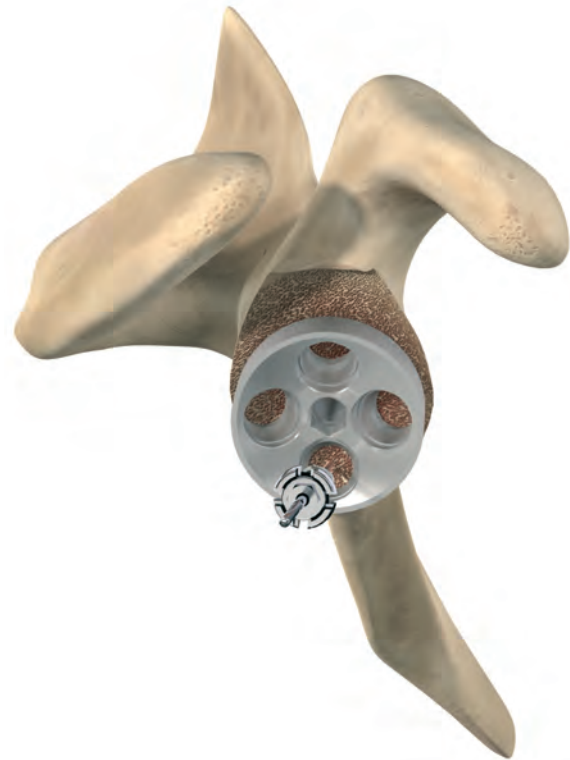

Figure 39

Slide the locking screw of the appropriate length onto the guide pin, having previously checked that it is unlocked (the internal tightening screw should rotate freely) (Figure 39).

Inferior and Superior Metaglene Screw Placement

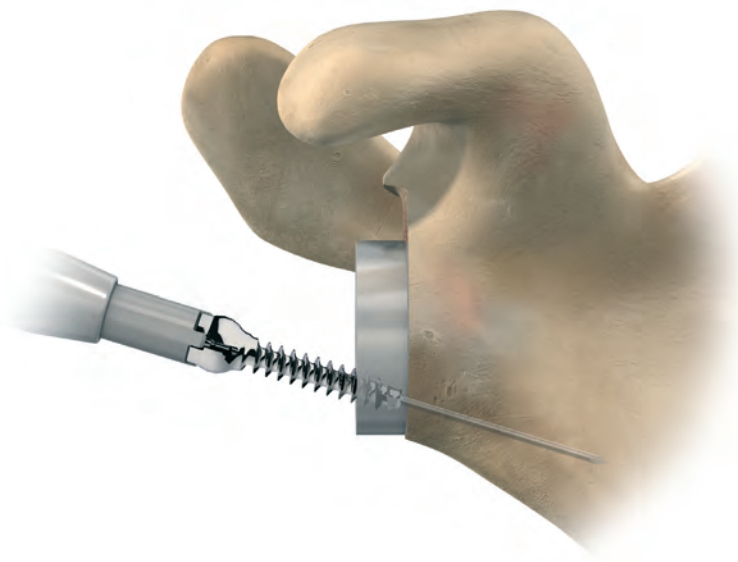

Figure 40

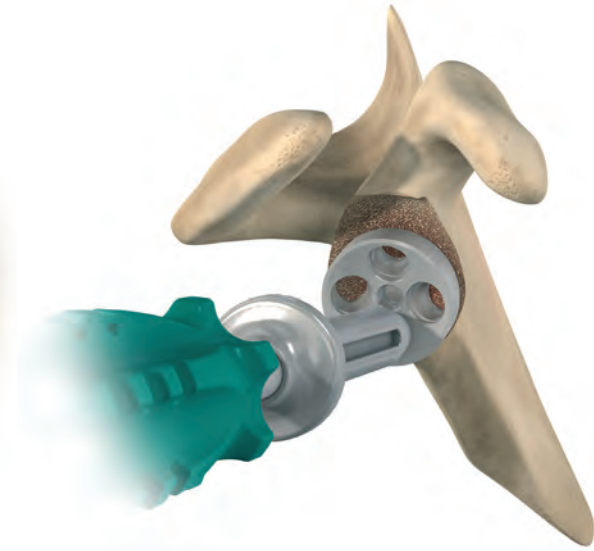

Figure 42

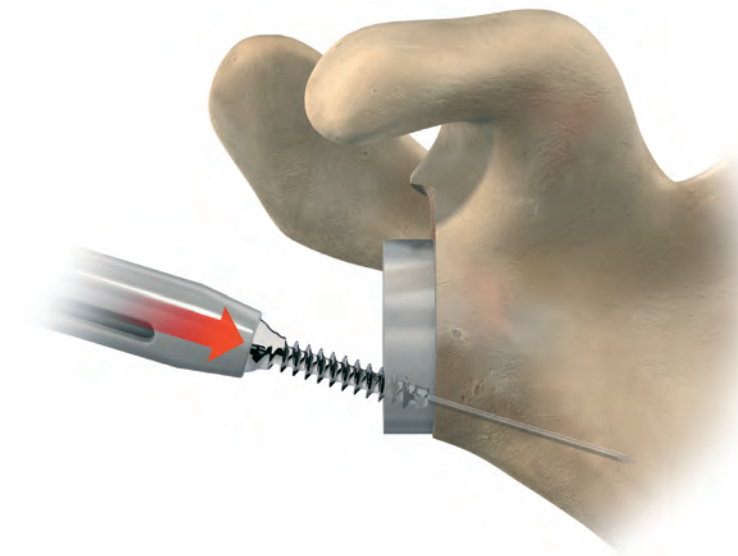

Figure 41



Figure 43

Slide the locking screwdriver main body down the guide pin and insert the screwdriver tip into the 4 slots of the screw (Figure 40). Do not use the internal screwdriver rod at this stage.

Warning: slide the screwdriver sleeve completely down to protect the screw head before screwing (Figure 41).

Tighten the screw to obtain metaglene plate compression (Figure 42).

Remove the screw guide pin using the pin extractor, making sure that the internal locking screw stays in place.

Repeat the same process to put the superior locking screw in place.

Drill the hole for the superior locking screw anticipating exit through the cortex. The superior screw should be directed at the base of the coracoid process and should have an anterior orientation to avoid the suprascapular nerve. A shorter screw is preferable to avoid nerve injury.

To obtain optimal compression of the metaglene plate on bone, tighten the superior and inferior locking screws alternately (Figure 43).

Anterior and Posterior Metaglene Screw Placement

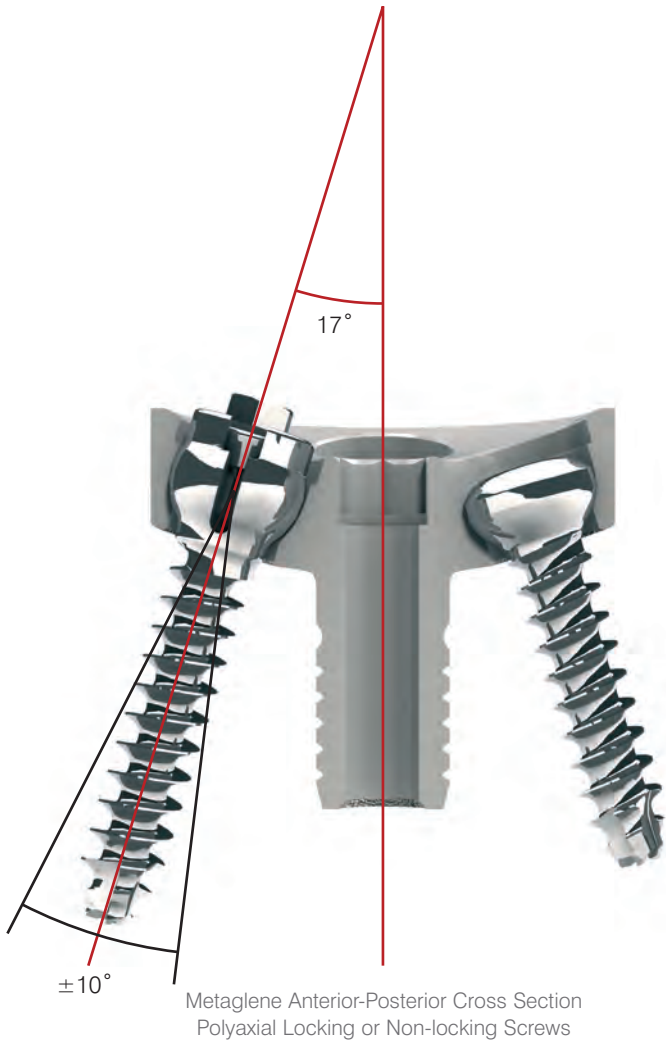

Figure 44

The surgeon may use locking or non-locking screws in the anterior or posterior holes. Both types of screws will allow an angulation of up to $\pm 10^\circ$, but **not** in a direction convergent to the central peg axis to avoid conflict with the peg when drilling (Figure 44).



Figure 45

Use the 2.5 drill bit with the drill guide to set the most appropriate angle for ensuring that each screw is located in good bone stock (Figure 45).

The preferred position is usually chosen by palpating the anterior and posterior aspects of the scapula as well as examining the X-rays and CT scans. Drill in the direction of the central glenoid vault in an attempt to maximise the anterior and posterior screw lengths, in a direction parallel to or divergent from the central peg.

Anterior and Posterior Metaglene Screw Placement



Figure 46

Screw length is determined from the laser marks on the drill bits or using the depth gauge. Place the guide pin in the drilled hole.

Slide the corresponding screw onto the guide pin and tighten using the 3.5 mm cannulated hex screwdriver for non-locking screws or the locking screwdriver for locking screws (Figure 46).

Follow the same procedure for the posterior screw. Then tighten all four screws alternately to obtain maximum compression.



Figure 47

Then proceed with locking the polyaxial screws. Place the locking screwdriver main body in place on the inferior screw head. **Make sure that the screwdriver sleeve is in its upper position and not in contact with the screw head anymore.**

Slide the locking screwdriver internal rod into the main handle. The tip of the internal rod will make contact with the screw head and tightening it fully will lock the screw in place by expanding its head (Figure 47).

Repeat the same operation to secure the superior locking screw and anterior or posterior screws, if polyaxial screws have been used.

The metaglene is now secure (Figure 48) and the humeral preparation can be carried out.



Figure 48

Placement of the Proximal Humeral Reaming Guide

Cementless & Cemented Humeral Implants

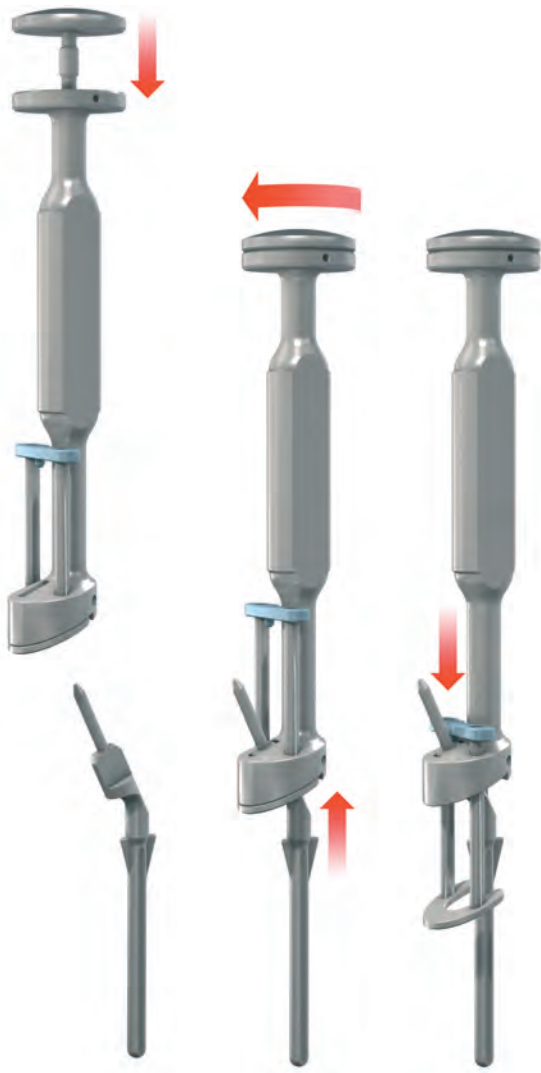

Figure 49

Figure 50

Figure 51

Select the appropriate proximal reaming guide size (Figure 49). For example, if a 12 mm intramedullary reamer and a 12 mm cutting handle were previously used, select the 12 mm proximal reaming guide.

Slide and screw the internal rod of the reaming guide holder into the holder main body. Then slide the reaming guide into the reamer holder and fasten the two parts together by firmly screwing in and tightening the upper round handle (Figure 50).

Push the holder horseshoe plate fully down (Figure 51).



Figure 52

Figure 53

Figure 54

Slide the proximal reaming guide down into the intramedullary canal, rotating it if necessary to ensure that the horseshoe plate sits flat on the bone resection surface (Figure 52).

Drive the proximal reaming guide down until achieving complete contact between the metal block and the resection bone surface (Figure 53).

Unscrew the upper round handle of the holder and remove the holder, leaving the proximal reamer guide in place (Figure 54).

The subsequent surgical steps depend on whether the humeral implant chosen is cementless or cemented. For cementless implants, see pages 27-31, for cemented implants see pages 32-33.

Proximal Humeral Reaming

Cementless Modular Humeral Implants



Figure 55

The size and type (centred or eccentric) of modular epiphysis should be chosen to ensure that the best possible coverage of the bone resection surface is achieved.

First select the centred proximal modular reamer adaptor, and place it on the reaming guide's angled pin.

Choose the most appropriate epiphysis size using the modular implant sizer disks, size 1 (green) or 2 (red). The sizer disk chosen should provide the best coverage of the bone resection surface without overlapping the bone (Figure 55).



Figure 56

If this does not provide a good fit with the bone resection surface, switch the centred proximal modular reamer adaptor for the eccentric adaptor in size 1 (green). **Be careful to position the eccentric adaptor so that the eccentricity is posterior and not anterior, double checking with the markings (anterior and posterior) on the adaptor.**

Then check the epiphysis size again with sizer disk 1 (green). If the bone coverage is not sufficient, use eccentric adaptor size 2 (red) and sizer disk size 2 (red) (Figure 56).

Use the colour code to verify compatibility of the reamer adaptor, sizing disk and reamer. All 3 components must have the same colour code. Remember the final decision taken, with respect to the centred or eccentric epiphysis and size 1 or 2. This will determine reamer and final implant sizes.



MAKE SURE YOU ARE USING THE DEDICATED INSTRUMENTS FOR CEMENTLESS MODULAR IMPLANTS

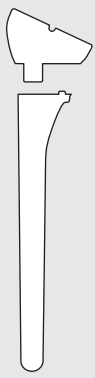

Proximal Humeral Reaming Cementless Modular Humeral Implants

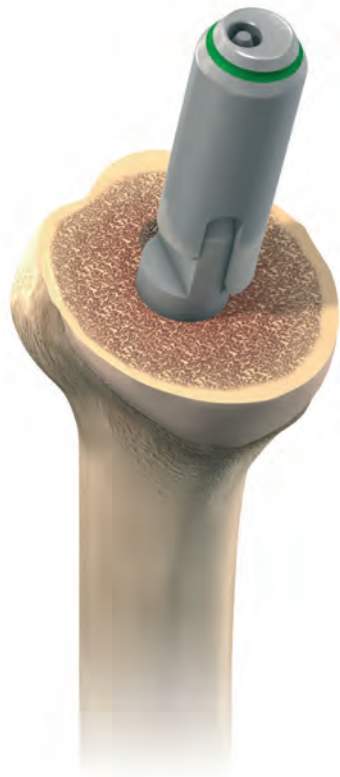

Figure 57

Remove the sizer disk, leaving the proximal modular reamer adaptor in place (Figure 57).

Select the appropriate proximal modular reamer in size 1 (green handle) or 2 (red handle), according to the results of the previous trials. Carry out the reaming using a power tool. Power reaming should always be carried out carefully, grasping the power tool handle with a sensitive and flexible hand grip.



Figure 58

Complete reaming has been achieved when the external reamer flange is in full and complete contact with the bone resection surface (Figure 58).

When proximal reaming has been completed, first remove the reaming adaptor. Then remove the reaming guide using the reaming guide holder. If any bone remains unreamed in the centre of the epiphysis, remove it.

Distal Humeral Broaching

Cementless Modular Humeral Implants

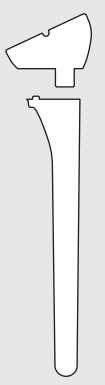

MAKE SURE YOU ARE USING THE DEDICATED INSTRUMENTS FOR CEMENTLESS MODULAR IMPLANTS

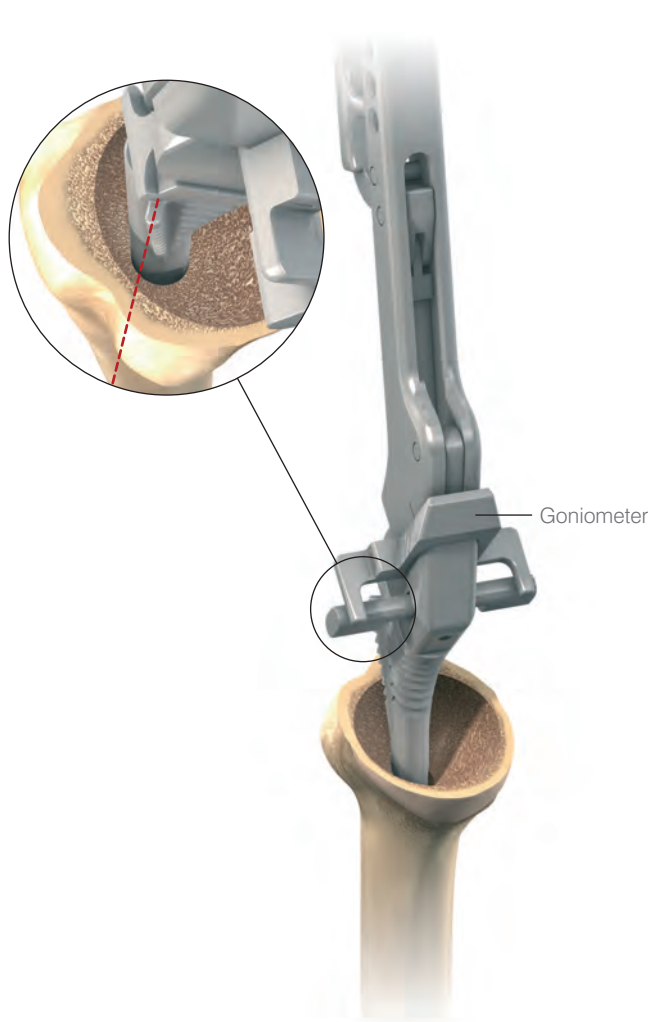

Figure 59

The correct stem size will have been determined already from the previous intramedullary reaming. If the 12 mm intramedullary reamer has been used, select the 12 mm broach and attach it to the broach handle. Make sure that the goniometer is in place on the broach handle.

Drive the broach into place, carefully checking that its anterior fin is aligned with the anterior aspect of the bicipital groove. This will ensure good distal stem orientation (anatomic version) for an optimised press-fit (Figure 59).

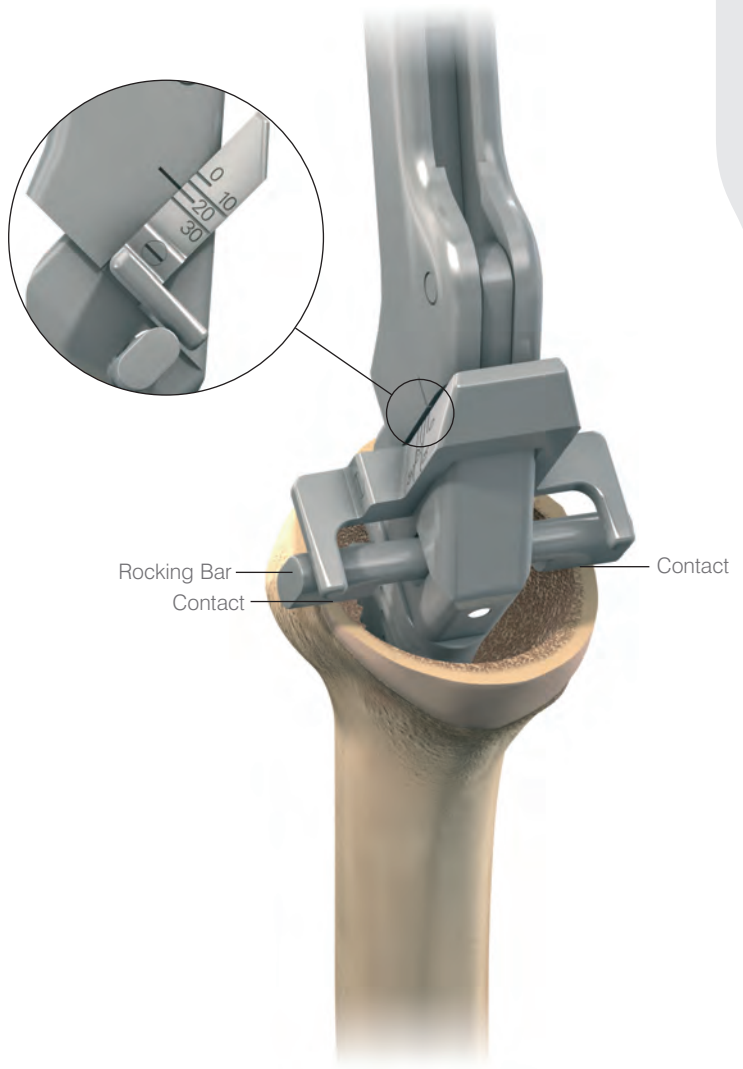
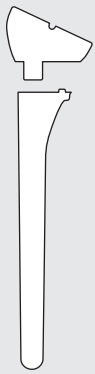

Figure 60

Drive the broach down carefully, (to avoid any cortical bone damage) until the rocking bar of the broach handle is in full contact with bone, both at the anterior and posterior aspects of the resection surface (Figure 60).

If there is cortical bone damage where the rocking bar should contact bone, slide the broach handle plate between the rocking bar and the bone resection surface.

Read the angulation which is automatically indicated on the instrument.



Humeral Trial Stem and Epiphysis Insertion

Cementless Modular Humeral Implants



Figure 61

The trial modular epiphysis (centred or eccentric, size 1 or 2, depending on the proximal reaming choices made) is placed on the trial modular stem (diameter chosen during distal reaming and broaching).

The epiphysis position corresponds to the angulation previously read on the broach handle goniometer. For example, if 20° right was read on the goniometer, the epiphysis hole marked 20° right should be positioned in line with the stem orientation peg (Figure 61).

This angulation corresponds to the difference between the version of the stem (close to anatomical retroversion 20° to 30°) and the epiphysis version for a reverse shoulder (close to 0° retroversion).



Figure 62

No calculation is required: the instrumentation has been designed to provide direct feedback of this position on the goniometer.

The two trial components are then screwed together using the 3.5 mm hex screwdriver (yellow handle) and the special locking wrench for modular implants (size 10-12 or 14-16) (Figure 62).

Both trial components are then mounted on the humeral implant driver by pushing and then releasing the blue button (Figure 63).



Figure 63

Humeral Trial Stem and Epiphysis Insertion

Cementless Modular Humeral Implants

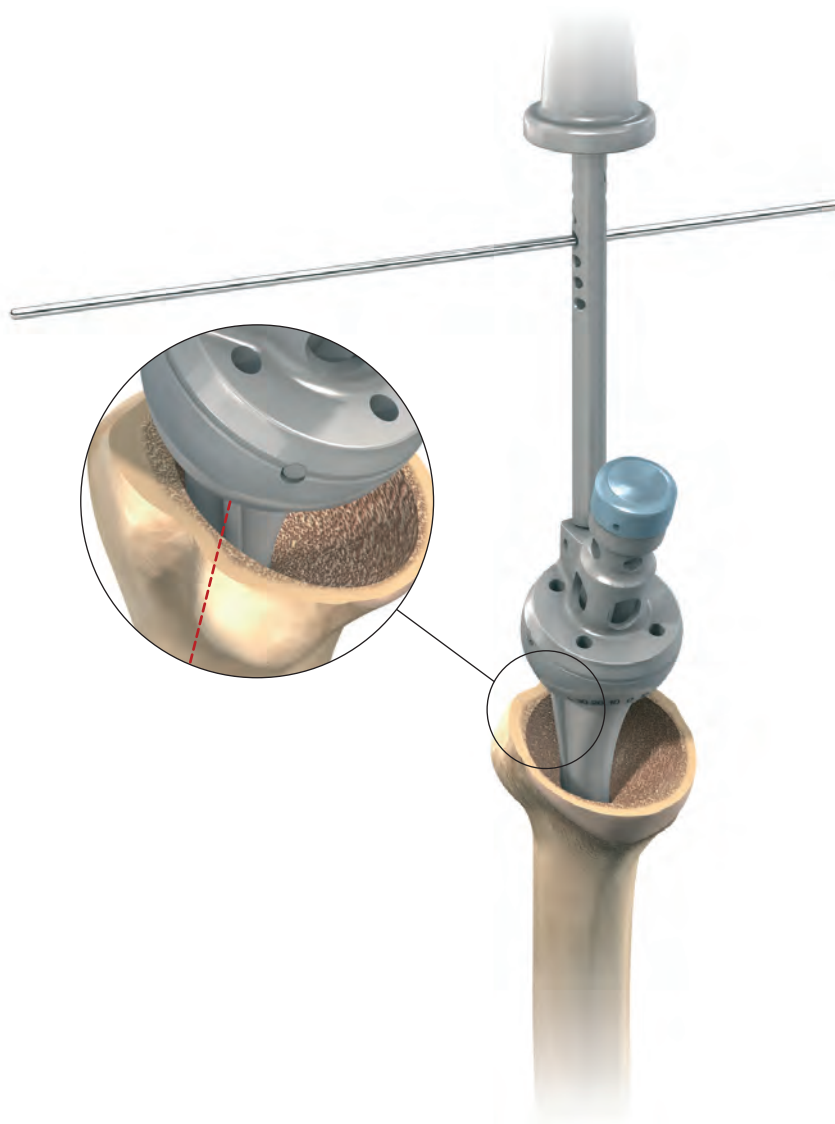

Figure 64

The trial component is then driven down the intramedullary canal, aligning the anterior fin of the stem with the anterior aspect of the bicipital groove.

The implant orientation can also be checked using the orientation pin placed in the implant driver handle. The pin should be placed in the same retroversion position used to position the cutting guide, i.e. close to 0° retroversion. The orientation pin should then be aligned with the forearm axis and the trial implants driven down (Figure 64).



Figure 65

Impact the trial implant by gently hammering the implant driver handle and remove the driver, leaving the trial implant in place (Figure 65). The driver is detached by pushing the blue button.

Continued on page 34.

MAKE SURE YOU ARE USING THE DEDICATED INSTRUMENTS FOR CEMENTLESS MODULAR IMPLANTS

Proximal Humeral Reaming

Cemented Monobloc Humeral Implants



Figure 66



Figure 67

Continued from page 26.

The monobloc implant size should be chosen to suit the initial distal reaming diameter and the size of epiphysis that is the best match for the bone stock.

Please note that monobloc humeral implants are designed to be cemented. Eccentric epiphyseal components are therefore NOT available for monobloc cemented humeral implants.

Choose the most appropriate epiphysis size by placing a monobloc implant sizer disk in size 1 (yellow) or 2 (blue) on the proximal reaming guide. The most appropriate size will be that of the sizer disc that provides the best possible coverage of the bone resection surface (Figure 66).

Remember the final decision taken, epiphysis size 1 or 2. This will determine reamer and final implant sizes.

Remove the sizer disk.

Select the appropriate proximal reamer for the monobloc implant, size 1 (yellow handle) or 2 (blue handle), depending on the results of the previous trials. Carry out the metaphyseal reaming using a power reamer (Figure 67). Use the colour code to check compatibility between the sizing disk chosen and the proximal reamer.

Complete reaming is achieved when the external reamer flange is in full and complete contact with the bone resection surface.

When the proximal reaming has been completed, remove the reaming guide using the reaming guide holder.

Humeral Trial Implant Insertion

Cemented Monobloc Humeral Implants

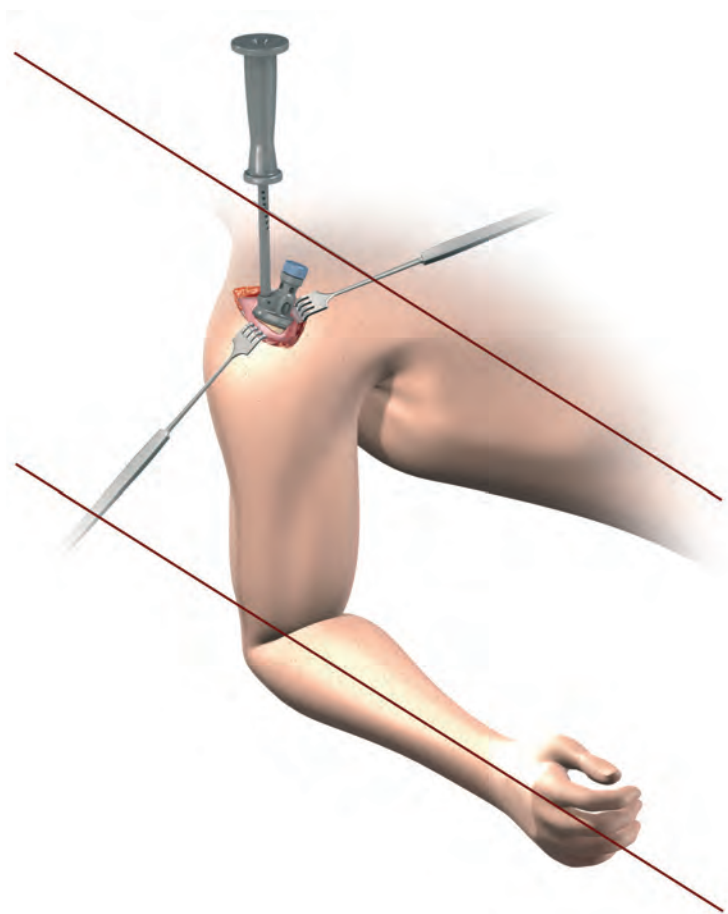

Figure 68

Select the appropriate trial humeral implant. For example, if the initial distal reaming was carried out using the 12 mm reamer and proximal reaming was carried out using the size 1 proximal reamer, select monobloc humeral trial epiphysis number 1 with diameter 12 mm.

Mount the trial implant on the humeral implant driver and drive it down the intramedullary canal.

The implant orientation should be checked using the orientation pin placed in the implant driver handle. The pin should be placed in the same retroversion position used to position the cutting guide, i.e. close to 0° retroversion. The orientation pin should then be aligned with the forearm axis and the trial implants driven down (Figure 68).



Figure 69

Impact the trial implant by gently hammering the implant driver handle and remove the driver, leaving the trial implant in place (Figure 69). The driver is detached by pushing on the blue button.

MAKE SURE YOU ARE USING THE DEDICATED INSTRUMENTS FOR CEMENTED MONOBLOC IMPLANTS



Glenosphere Trial Placement

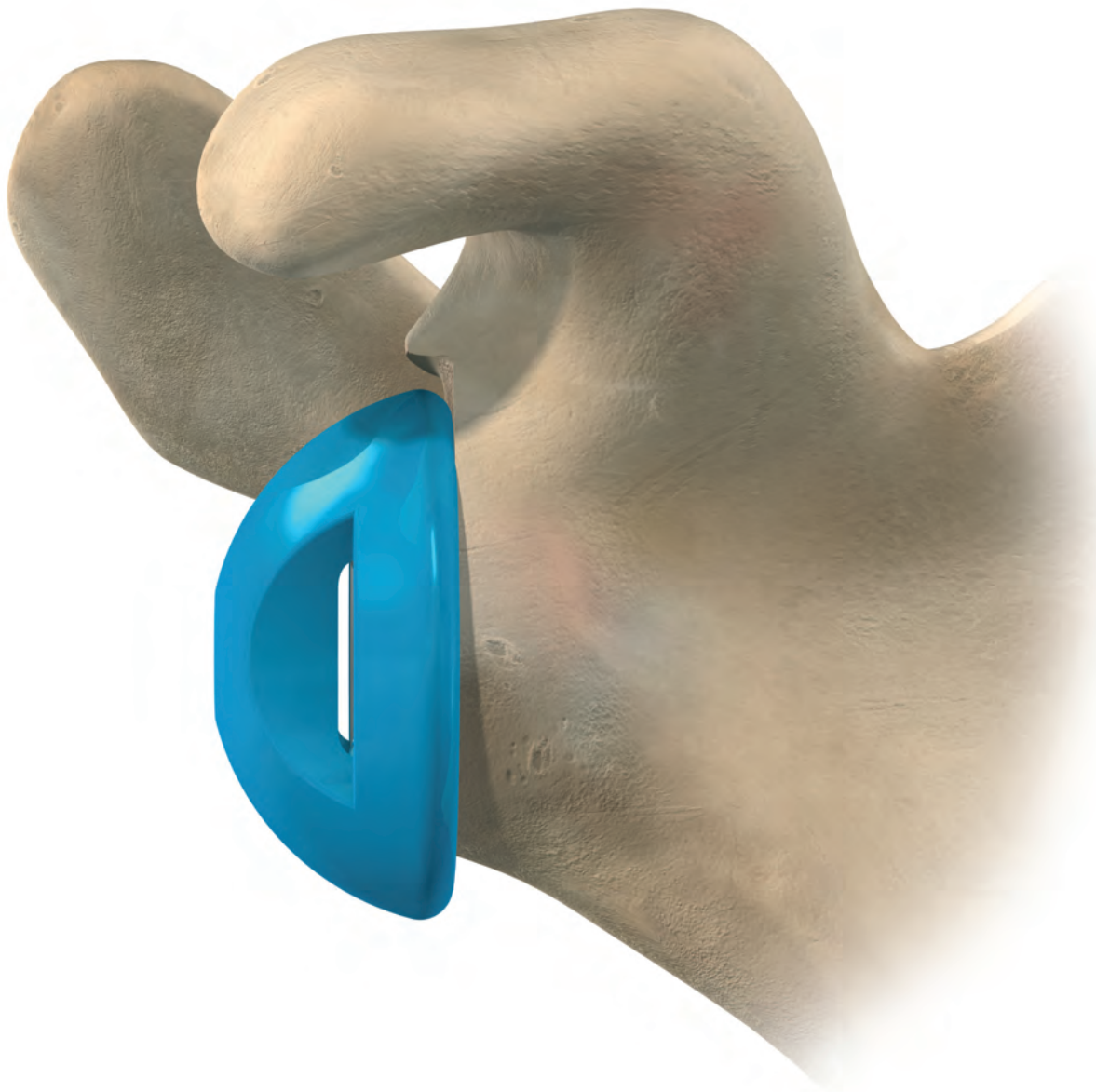

Figure 70

The glenosphere implants are available in two diameters, 38 mm and 42 mm, and are either standard or eccentric spheres.

An overlap of 3 to 5 mm below the glenoid inferior limit is recommended to avoid scapular pillar conflict (Figure 70). Depending on the glenoid pillar shape, this overlap can be achieved using the standard glenosphere, just by lowering the metaglene. If the size of the joint (once exposed) allows, it is recommended to use the 42 mm glenosphere. The eccentric glenospheres are recommended for more vertical pillars.



Cup Trials and Trial Reduction

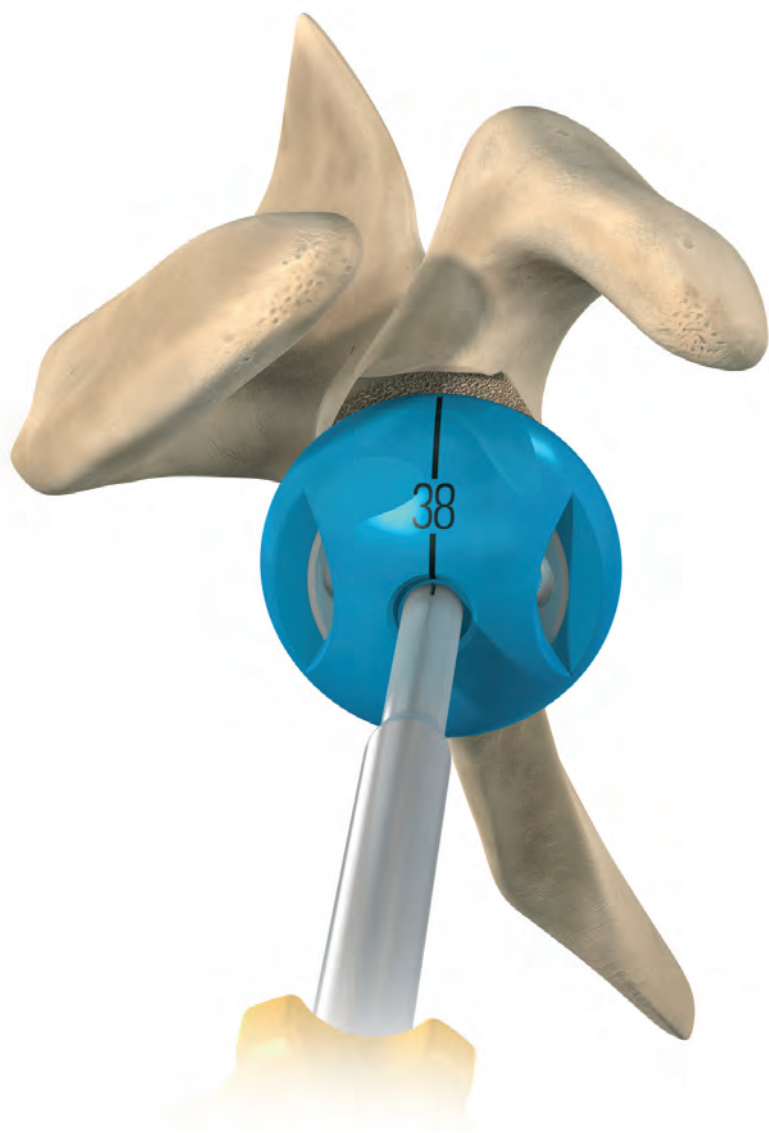
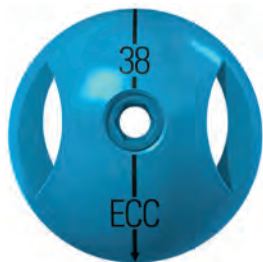

Figure 71

Fit the appropriate trial glenosphere (38 mm or 42 mm, centred or eccentric) to the metaglene using the metaglene holder (Figure 71).



For eccentric glenospheres, the vertical laser marking of the trial glenosphere should be aligned with the base of the coracoid superiorly and with the scapula pillar inferiorly. The arrow indicates the position of the eccentricity and should be positioned postero-inferiorly, aligned with the mid-line of the scapular pillar.

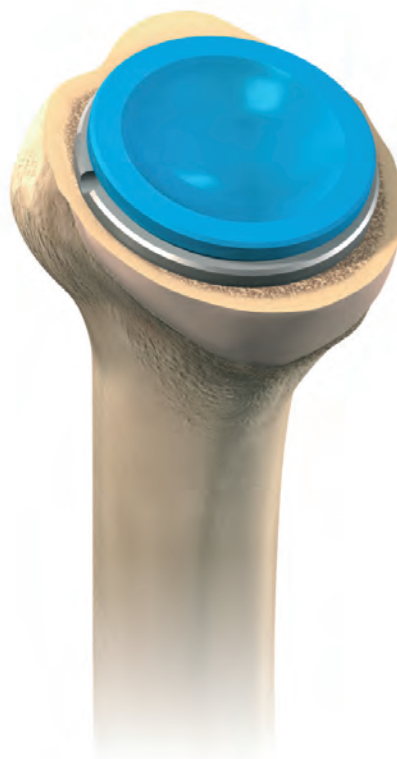

Figure 72

First place the high mobility humeral trial cup (38 or 42 mm depending on the glenosphere size), which is 3 mm thick, in the trial epiphysis (Figure 72). The shoulder should then be reduced with longitudinal traction and assessed for a full range of motion.

Joint Tensioning and Stability Assessment

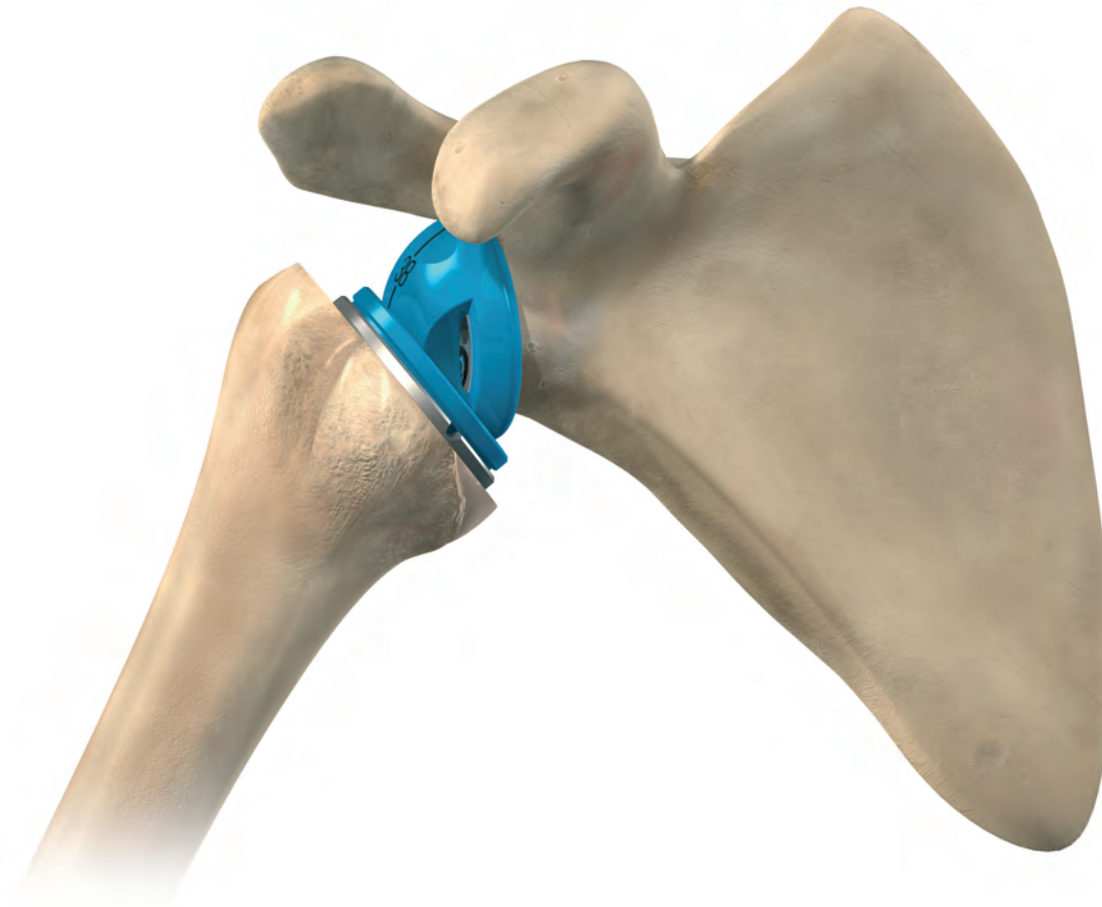

Figure 73

Joint tensioning and stability assessment should be performed with particular care, using the following guidelines:

- Tension within the conjoined tendon should be noticeably increased and detectable by palpation.
- With the arm in a neutral position, apply a longitudinal traction force to the arm while observing the movement of the shoulder with respect to the entire shoulder girdle as well as the trial prosthetic joint. Tension is appropriate if, in response to the longitudinal traction, the entire shoulder moves before detectable separation of the trial prosthetic surfaces. The articular surfaces should still move smoothly relative to each other and the joint reduction should be achieved without excessive force.
- External rotation may appropriately demonstrate slight gaping between the glenosphere and articular surface (2 to 3 mm maximum).
- Positioning a hand or fist near the axilla to serve as a fulcrum, further adduct the arm and look for undesirable tendencies to sublux or dislocate laterally (a small opening of 2 to 3 mm is acceptable). Estimate the maximum forward elevation.
- Assess stability at 90° abduction with the humerus in neutral, maximum internal and maximum external rotation. Estimate also the maximum forward elevation.¹⁵

If instability can be demonstrated, it is critical to attempt to identify the cause and rectify. Make sure that the trial implants have been positioned correctly with respect to the bone and to each other. Overcome any conflicts between the proximal humeral component and soft tissues or bony structures that surround the glenosphere (e.g. a non-united greater tuberosity) by excision of the conflicting elements. Inadequate tensioning may be overcome using:

- a thicker cup (+6 mm or +9 mm)
- a standard cup instead of a high mobility cup
- a 42 mm glenosphere.
- **In more extreme cases:** a modular humeral lengthener or a retentive cup.

If unable to relocate the humerus, the options include changing to a thinner articular surface, additional soft tissue releases and lowering the level of humeral resection.

When the trials are satisfactory, the trial glenosphere should be removed using the extraction T-handle so that final implant fixation can be performed.

A 1.5 mm glenosphere guide pin is inserted through the central hole of the metaglene.

Definitive Glenosphere Fixation

Standard Glenosphere



Figure 74



Figure 75

Standard glenosphere

Engage the 3.5 mm cannulated hex screwdriver in the implant glenosphere. Slide the glenosphere on the 1.5 mm guide pin until it is in contact with the metaglene (Figure 74). **Proper alignment** between the glenosphere and metaglene is absolutely essential to avoid cross threading between the components.

Proper alignment leads to smooth thread engagement and easy screwing. If the glenosphere seems difficult to thread onto the metaglene, do not force engagement but re-align the components. If necessary remove the inferior retractor or improve the capsular release. It is also important to check that there is no soft tissue between the metaglene and glenosphere.

When accurate thread engagement is obtained and after a few turns, remove the guide pin to avoid stripping in the screwdriver.

Tighten until the scapula begins to rotate slightly in a clockwise direction in response, meaning that the glenoid bearing is closing on the taper of the metaglene.

Obtain further impaction of the junction by gently hammering the glenosphere with the glenosphere impactor a minimum of three times, using at least a 700g hammer (Figure 75). Then tighten the glenosphere central screw again. Care should be taken to ensure that the glenoid bearing is fully locked onto the metaglene. The gentle hammering procedure and screw tightening can therefore be repeated if necessary until further screw tightening, without excessive torque, is not possible.

Definitive Glenosphere Fixation

Eccentric Glenosphere

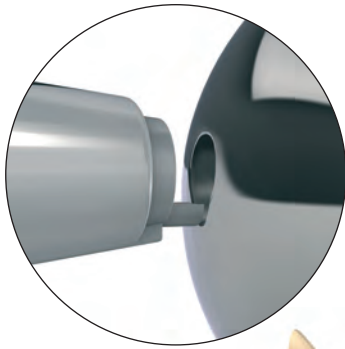

Figure 76



Figure 77

Eccentric glenosphere

Slide the eccentric glenosphere on the 1.5 mm guide pin. Slide the glenosphere orientation guide onto the screwdriver core and position it in the eccentric glenosphere central slot (Figure 76).

The arrow marked on the orientation guide should be aligned with the base of the coracoid process to position the eccentricity correctly. Maintain the orientation guide in the required position and screw the glenosphere into place using the screwdriver until the glenoid bearing closes on the taper of the metaglene (Figure 77). Remove the guide pin.

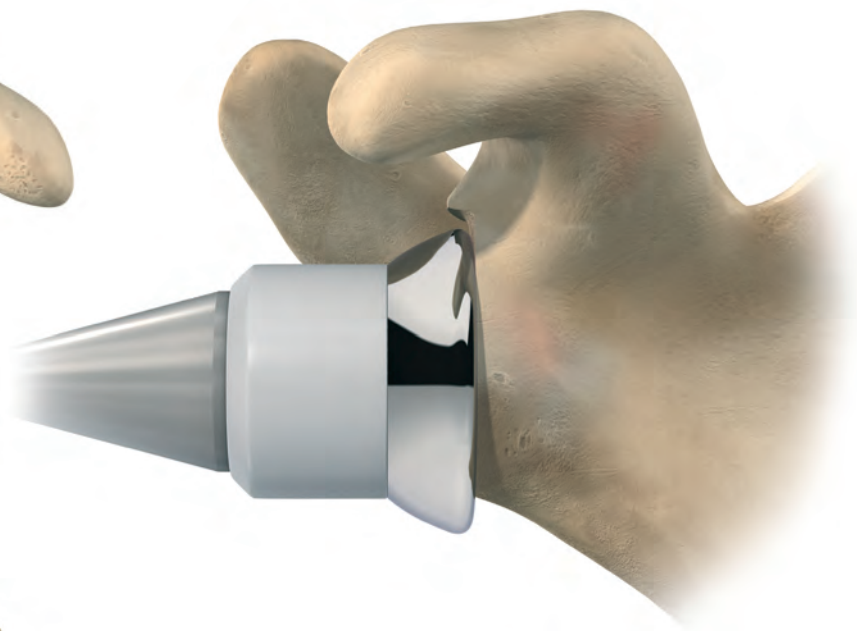

Figure 78

Obtain further impaction of the junction by gently hammering the glenosphere with the glenosphere impactor a minimum of three times, using at least a 700 g hammer (Figure 78). Then tighten the glenosphere central screw again. Care should be taken to ensure that the glenoid bearing is fully locked onto the metaglene. The gentle hammering and screwing procedure can therefore be repeated if necessary, until further screw tightening, without excessive torque, is not possible.



Glenosphere Removal

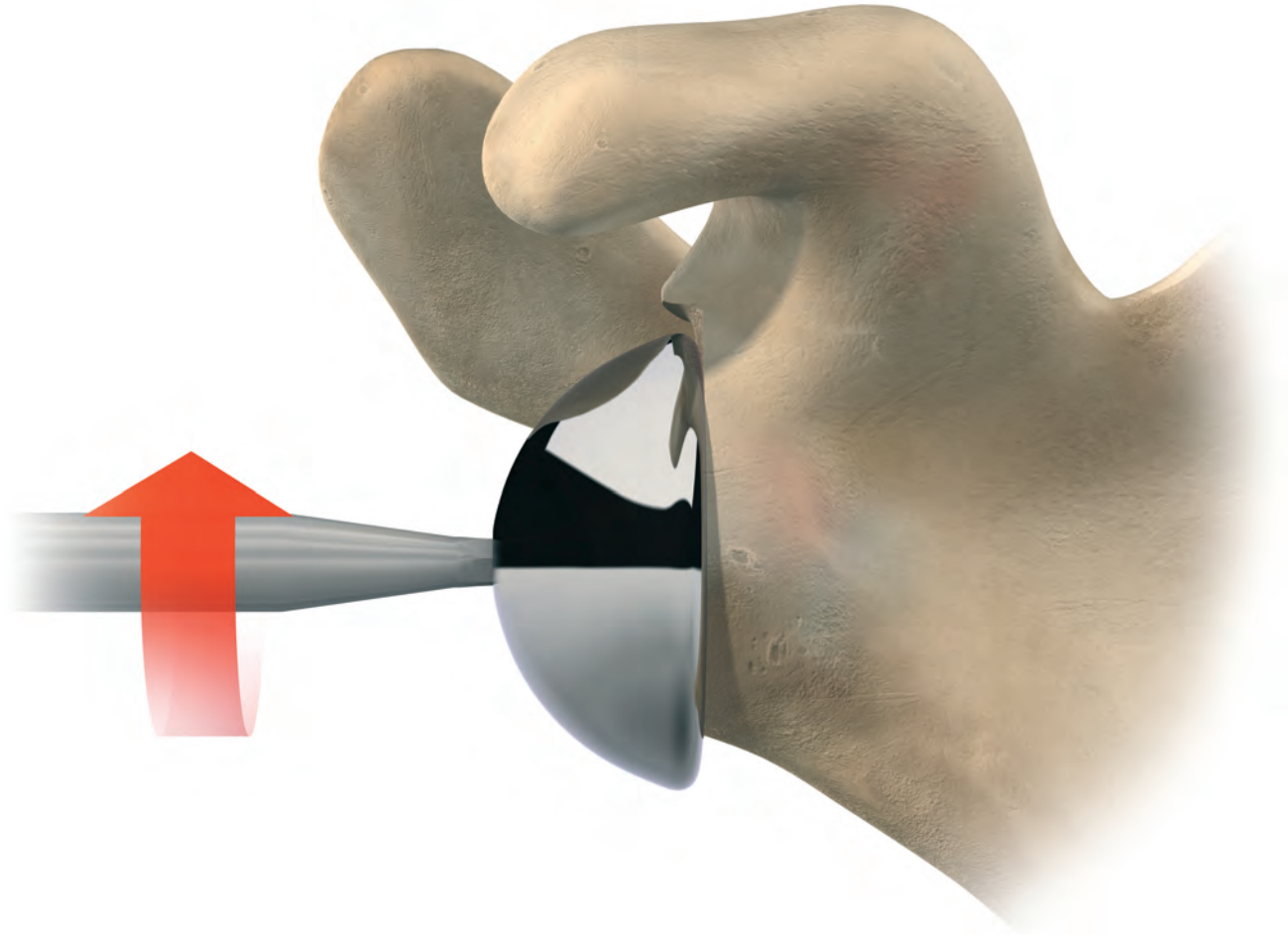
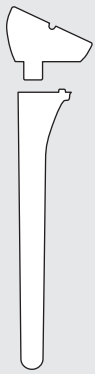

Figure 79

If it is necessary to remove the glenosphere (revision or intra-operative size modification), the glenosphere/metaglene junction can be disassembled by unscrewing the glenosphere central screw using the 3.5 hex head screwdriver (yellow handle) (Figure 79). This option is possible due to the design of a specific internal screw system inside the glenosphere component. This step should be done smoothly to avoid central screw damage.





Definitive Humeral Implants Insertion Cementless Modular Humeral Implants



Figure 80

Remove the trial cup and trial humeral implant using the humeral implant driver.

Select the appropriate final modular humeral implants that correspond to the trial implants.

Place the final modular epiphysis on the final modular stem in the same rotational position used for the trial implants (Figure 80).

Screw the final modular epiphysis together with the final humeral stem, using the 3.5 mm hex screwdriver (yellow handle) and the special locking wrench for modular implants (size 10-12 or 14-16) (Figure 81).



Figure 81

Both components should then be mounted on the humeral implant driver and driven down the intramedullary canal, aligning the lateral fin of the stem with the bicipital groove (Figure 82). The epiphysis border should be aligned with the bone resection border.



Figure 82

Definitive Humeral Implants Insertion

Cementless Modular Humeral Implants

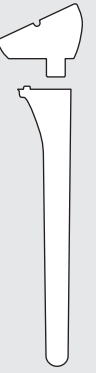

MAKE SURE YOU ARE USING THE DEDICATED INSTRUMENTS FOR CEMENTLESS MODULAR IMPLANTS

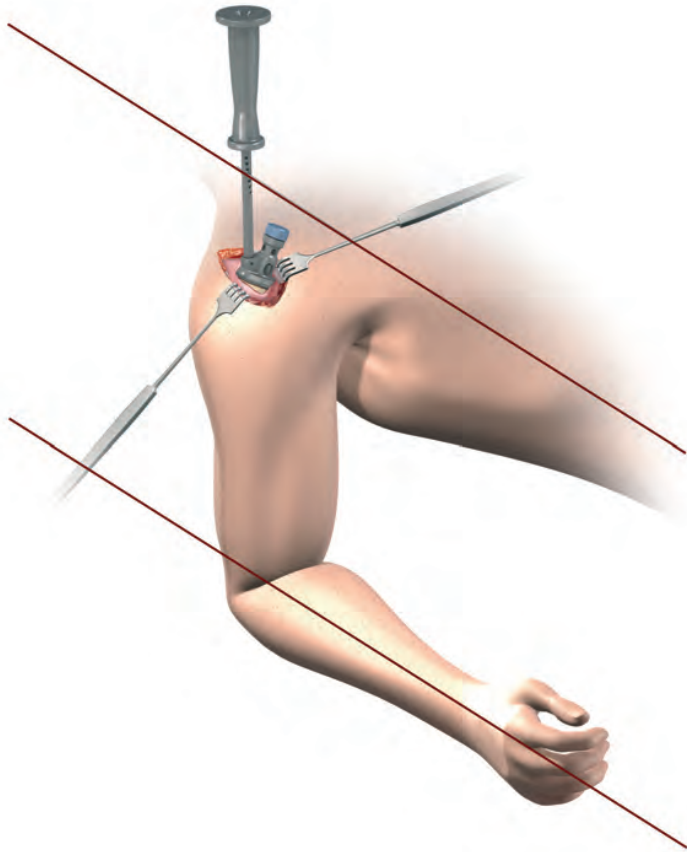

Figure 83

Implant orientation can also be checked using the orientation pin placed in the implant driver handle. The pin should be placed in the same retroversion position used to position the cutting guide, i.e. close to 0° retroversion. The orientation pin should then be aligned with the forearm axis and the implants driven down (Figure 83).



Figure 84

Impact the final press-fit humeral implant by hammering gently on the implant driver handle (Figure 84).

Note: the final modular humeral implants are larger by 0.5 mm than the trial implants to ensure an optimal press-fit.



Figure 85

Impact the final humeral cup using the cup impactor (Figure 85). When a humeral spacer is needed impact it first on the epiphysis and then impact the final cup on it.

Note: all junction surfaces between implant components should be clean and free of any tissue before impaction.

Definitive Humeral Implants Insertion

Cemented Monobloc Humeral Implants



Figure 86

Remove the trial cup and humeral implant using the humeral implant driver. Select the appropriate final monobloc humeral implant corresponding to the trial implant.

Inserting cement restrictor

Determine the trial size of the cement restrictor and gauge the implantation depth (Figure 86). Check that the trial restrictor is firmly seated in the canal. Then remove the trial restrictor.

Use pulsatile lavage and a nylon brush to clear the humeral canal of debris and to open the interstices of the bone ready for the cement. Place the definitive cement restrictor at the appropriate depth and check that it is firmly seated in the canal.

Pass non-absorbable sutures through the proximal humerus near the lesser tuberosity to enable secure re-attachment of the subscapularis (if possible). Avoid re-attachment if unable to externally rotate the humerus to zero degrees.

Irrigate the canal, during a second cleaning stage, using pulsatile lavage removing loose bone remnants and marrow. Some surgeons may wish to insert a one-inch gauze pre-soaked in an epinephrine (1:1,000,000 solution) or hydrogen peroxide solution to aid haemostasis and the drying of the humeral canal (Figure 87).



Figure 87

Cement preparation

Antibiotic-impregnated cement is recommended, particularly in revision cases, such as the SmartSet® GHV Gentamicin bone cement from DePuy CMW. Mix cement using a classical technique or using the Cemvac® syringe vacuum mixing system. Attach the syringe to the Cemvac® cement injection gun and assess the viscosity. The cement is ready for insertion when it has taken on a dull, doughy appearance and does not adhere to the surgeon's glove.

Once the cement has reached the correct viscosity, fill the humeral canal in a retrograde manner using appropriate nozzle attachments if required. Allow the cement to push the nozzle gently back until the canal is completely filled and the distal tip of the nozzle is clear of the canal. Apply slight manual pressurisation, to hold back any back bleeding pressure whilst the cement is penetrating the cancellous bone, to form an even cement mantle.

For full description see the DePuy CMW cementing technique catalogue.

Definitive Humeral Implants Insertion

Cemented Monobloc Humeral Implants

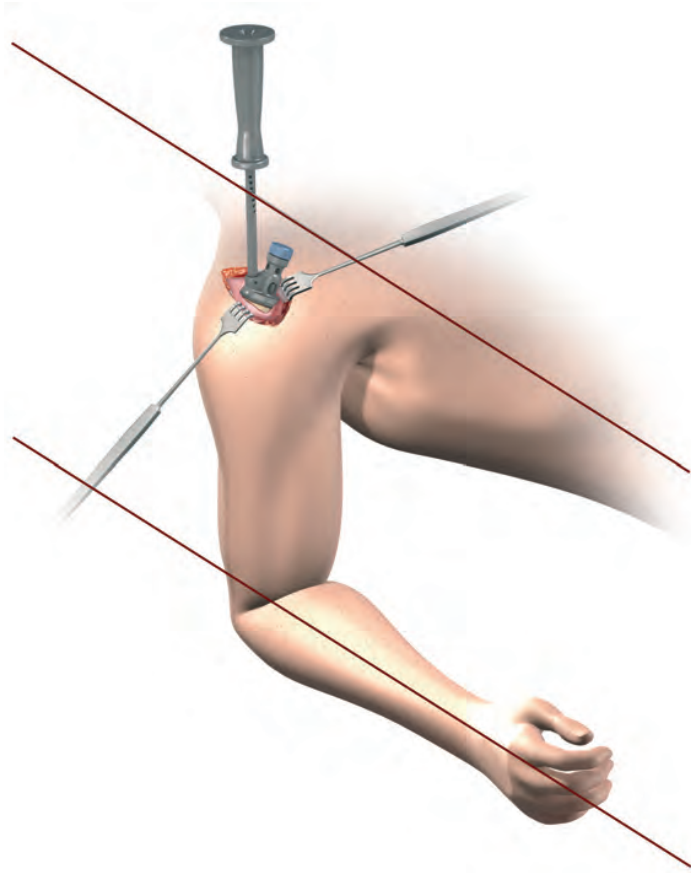

Figure 88

Implant insertion

Introduce the final implant in the chosen version in line with the long axis of the humerus, using the humeral implant driver (0° to 10° of retroversion) (Figure 88).

Excess cement will extrude from the canal and should be removed before curing is complete. Inspect the exposed portion of the humeral component for any inadvertently deposited cement and remove as necessary. Maintain pressure on the driver until the cement is fully polymerised to avoid micromotion that could cause crack propagation. Irrigate the wound thoroughly. Place the trial articular surface and reduce the joint. Confirm stability and dislocate the humerus.

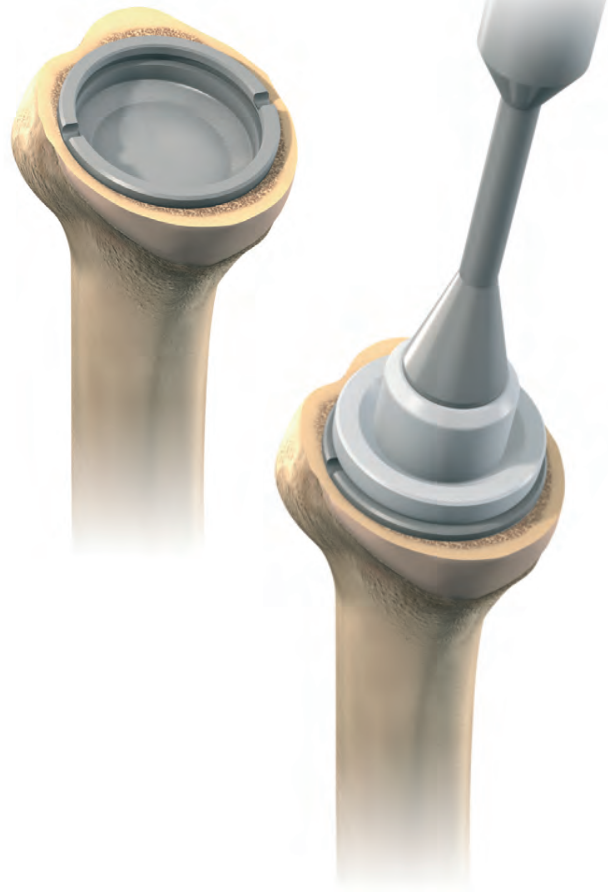

Figure 89

Final cup fixation

After thorough cleaning impact the final humeral cup using the cup impactor (Figure 89). When a humeral spacer is needed impact it first on the epiphysis and then impact the final cup on it.

Note: all junction surfaces between the implant components should be clean and free of any tissue before impaction.

Reduce the joint and carry out a final assessment of joint stability and range of motion.

MAKE SURE YOU ARE USING THE DEDICATED INSTRUMENTS FOR CEMENTED MONOBLOC IMPLANTS

Cases of Proximal Humeral Bone Loss



Figure 90

Cases of proximal bone loss should be treated using monobloc cemented humeral implants to avoid any risk of component dissociation. Long monobloc stems may be required in some cases.

The preparation of the humeral canal for long stems uses the same technique described for standard stems, with the exception of the procedure for reaming the humeral canal, which differs in this respect: the entire length of the cutting flutes should be passed down the intramedullary canal instead of being stopped at the mark (Figure 90).

A positioning jig is available to hold both the trial long stem and then the final implant in place at the correct height and retroversion position.

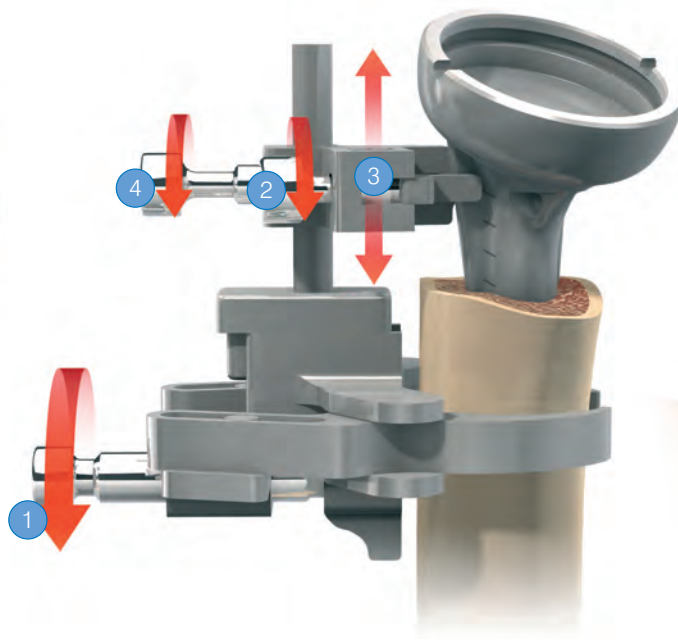

Figure 91

Tighten the fin clamp on the humeral shaft first using the 3.5 mm screwdriver (yellow handle) ① (Figure 91). Note that aligning the retroversion guide pin with the forearm places the implant in 30° retroversion. Re-adjust the retroversion of the jig to match 0° to 10° retroversion as used for the reverse shoulder prosthesis (Figure 92).

Place the fin clamp over the vertical height gauge of the humeral shaft clamp and secure the fin clamp to the hole in the anterior fin of the prosthesis. ② Place the trial prosthesis at the appropriate height ③ and tighten the fin clamp to secure it to the vertical height gauge. ④

Check the range of motion. Remove the trial stem leaving the jig in place. Perform the cementing technique as described (page 42). Assemble the fin clamp to the middle hole of the final implant. Introduce the definitive stem at the height determined using the jig.

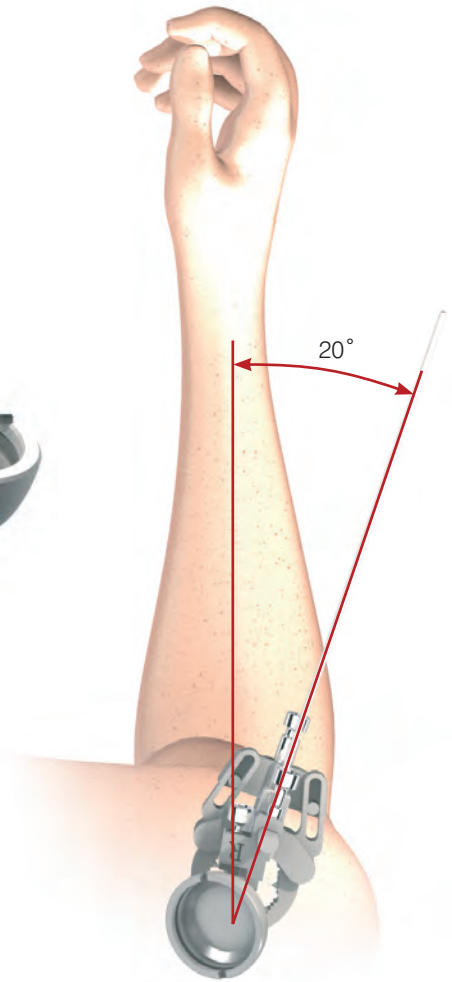

Figure 92



Cases of Proximal Humeral Bone Loss



Figure 93

Lines are also present on the trial long stems to enable better marking of the appropriate prosthesis height. Select the appropriate mark, then place the trial stem beside the final implant and mark off the corresponding height on the implant (Figure 93). Use this mark to cement the stems at the proper height.

Sutures can be placed through the stem fin holes (smooth edges) to reconstruct the proximal humerus.



Revision to Hemi-Arthroplasty

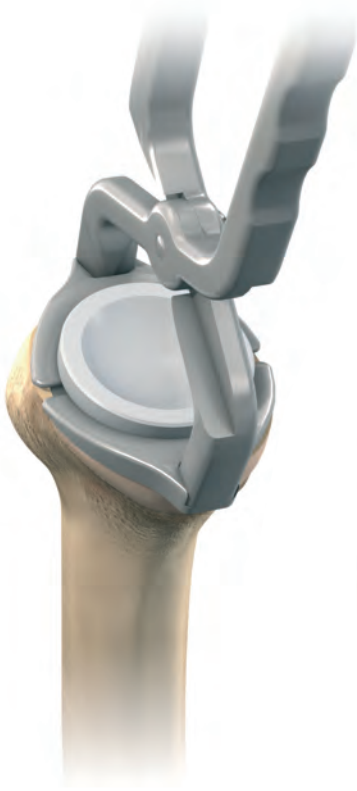

Figure 94



Figure 95



Figure 96

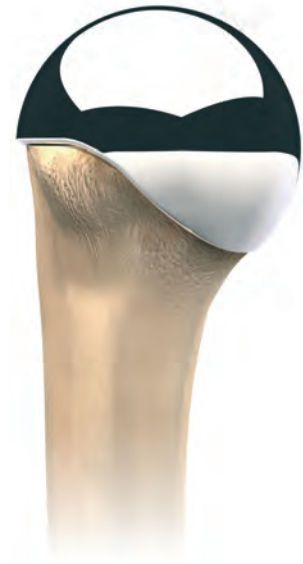

Figure 97

When revision of a reverse shoulder is required due to glenoid loosening, or when glenoid bone stock is insufficient to fix a metaglene securely, the reverse shoulder can be converted to an hemi-prosthesis as a salvage procedure. Specific hemi-heads with increased cover, Delta Xtend™ CTA heads, are available.

This technique can be used both for revision of cemented monobloc implant or cementless modular implant.

Remove the glenosphere using the 3.5 hex head screwdriver (yellow handle). Remove the metaglene locking screws using the locking screwdriver and the non-locking screw using the 3.5 mm hex head screwdriver.

Remove the metaglene using the extraction T-handle.

Remove the humeral cup using the cup extraction clamp (Figure 94).

Place the Delta Xtend™ CTA head reamer guide in the epiphysis (Figure 95). Align the anterior and posterior slot of the reaming guide with the slots of the epiphysis and impact the reaming guide gently with a mallet.

Assemble the Delta Xtend™ CTA head reamer with the T-handle. Ream the area around the epiphysis using a power tool (Figure 96). If the Delta Xtend™ CTA head trial does not obtain perfect seating on the epiphysis, finish the preparation using appropriate rongers.

Choose the appropriate size of Delta Xtend™ CTA head using the trial heads. The version of the head should be chosen to match the patient anatomy. This requires that the head is rotated in the proper orientation before impacting.

Then gently impact the appropriate final head implant using the humeral head impactor (Figure 97). **Make sure that the junction surfaces between the components are clean and free of any soft tissue before impaction.**

Closure



Irrigate the joint space and clear it of any remaining debris. Then repair the subscapularis if possible, but in doing so retain the ability to externally rotate to at least 0°. The anterior deltoid should be firmly sutured at the fibrous acromial perimeter or using transosseous stitches.

Next, place a drain beneath the delto-pectoral interval, close it using zero or number one absorbable sutures. Then close the subcutaneous tissue with a 2.0 absorbable suture. Finally, approximate the skin edges with adhesive paper tape and follow with a sterile dressing. Layered closure of the soft tissues normally leads to an adequate range of motion without instability.

Post-Operative Management

Appropriate post-operative physiotherapy is an important factor in the outcome of this procedure, since stability and mobility now depend on the deltoid alone. The physiotherapy programme, which should be planned to suit each individual patient, consists of two phases:

1. Early phase (0 to 6 weeks)

Two days after the operation, the patient can be mobilised. This early phase is dedicated to gentle and gradual recovery of the passive range of shoulder motion: abduction of the scapula, anterior elevation and medial and lateral rotation. An abduction cushion may be used to relieve deltoid tension. Physiotherapy is predominantly performed with the patient supine, passive and with both hands holding a bar that is manipulated by the contralateral hand, as described by Neer. The patient is encouraged to use the affected arm post-operatively to eat and write, but should not use it to push behind the back or to raise themselves from the sitting position to the standing position. In conjunction with these exercises for scapulohumeral recovery, it is important to strengthen muscle connection with the scapula in order to facilitate muscle and implant function. Passive exercise in a swimming pool is recommended as soon as scars begin to form. More caution is required to protect the deltoid muscle from excessive demand if a superior approach has been used for surgery.

2. Late phase (after 6 weeks)

After the sixth or seventh week, active strengthening movements may gradually be added to the programme. These exercises, which closely follow everyday activities, are to be performed in a sitting or standing position using conventional methods, with isometric exercises and resistance movements becoming increasingly important. A series of exercises for rhythmic stabilisation of the upper arm as well as eccentric work on lowering the arms complete the strengthening of the muscles. Physiotherapy should be performed until satisfactory autonomy is reached by the patient.

Ordering Information

Implants

STANDARD IMPLANT CODES

Cemented Monobloc Humeral Implant

Cat No.	Description
1307-08-100	Cemented Monobloc Humeral Implant - Epiphysis Size 1, Diameter 8 mm, Standard Length
1307-10-100	Cemented Monobloc Humeral Implant - Epiphysis Size 1, Diameter 10 mm, Standard Length
1307-12-100	Cemented Monobloc Humeral Implant - Epiphysis Size 1, Diameter 12 mm, Standard Length
1307-14-100	Cemented Monobloc Humeral Implant - Epiphysis Size 1, Diameter 14 mm, Standard Length
1307-10-200	Cemented Monobloc Humeral Implant - Epiphysis Size 2, Diameter 10 mm, Standard Length
1307-12-200	Cemented Monobloc Humeral Implant - Epiphysis Size 2, Diameter 12 mm, Standard Length
1307-14-200	Cemented Monobloc Humeral Implant - Epiphysis Size 2, Diameter 14 mm, Standard Length



Cementless Modular Humeral Implants

1307-10-000	Cementless Modular Humeral Stem, Diameter 10 mm, HA Coated
1307-12-000	Cementless Modular Humeral Stem, Diameter 12 mm, HA Coated
1307-14-000	Cementless Modular Humeral Stem, Diameter 14 mm, HA Coated
1307-16-000	Cementless Modular Humeral Stem, Diameter 16 mm, HA Coated
1307-20-101	Cementless Modular Centred Epiphysis Size 1, HA Coated
1307-20-102	Cementless Modular Eccentric Epiphysis Size 1, Left, HA Coated
1307-20-103	Cementless Modular Eccentric Epiphysis Size 1, Right, HA Coated
1307-20-201	Cementless Modular Centred Epiphysis Size 2, HA Coated
1307-20-202	Cementless Modular Eccentric Epiphysis Size 2, Left, HA Coated
1307-20-203	Cementless Modular Eccentric Epiphysis Size 2, Right, HA Coated



Polyethylene Cups and Humeral Spacer

1307-38-003	High Mobility Humeral Polyethylene Cup, Diameter 38 mm, +3 mm
1307-38-006	High Mobility Humeral Polyethylene Cup, Diameter 38 mm, +6 mm
1307-38-009	High Mobility Humeral Polyethylene Cup, Diameter 38 mm, +9 mm
1307-42-003	High Mobility Humeral Polyethylene Cup, Diameter 42 mm, +3 mm
1307-42-006	High Mobility Humeral Polyethylene Cup, Diameter 42 mm, +6 mm
1307-42-009	High Mobility Humeral Polyethylene Cup, Diameter 42 mm, +9 mm
1307-38-203	Standard Humeral Polyethylene Cup, Diameter 38 mm, +3 mm
1307-38-206	Standard Humeral Polyethylene Cup, Diameter 38 mm, +6 mm
1307-38-209	Standard Humeral Polyethylene Cup, Diameter 38 mm, +9 mm
1307-42-203	Standard Humeral Polyethylene Cup, Diameter 42 mm, +3 mm
1307-42-206	Standard Humeral Polyethylene Cup, Diameter 42 mm, +6 mm
1307-42-209	Standard Humeral Polyethylene Cup, Diameter 42 mm, +9 mm
1307-38-106	Retentive Humeral Polyethylene Cup, Diameter 38 mm, +6 mm
1307-42-106	Retentive Humeral Polyethylene Cup, Diameter 42 mm, +6 mm
1307-30-009	Humeral Spacer, +9 mm



Glenoid Implants

1307-60-038	Eccentric Glenosphere Diameter 38 mm
1307-60-042	Eccentric Glenosphere Diameter 42 mm
1307-60-138	Standard Glenosphere Diameter 38 mm
1307-60-142	Standard Glenosphere Diameter 42 mm
1307-60-000	Metaglène
1307-70-018	Non Locking Metaglène Screw Diameter 4.5 mm, Length 18 mm
1307-70-024	Non Locking Metaglène Screw Diameter 4.5 mm, Length 24 mm
1307-70-030	Non Locking Metaglène Screw Diameter 4.5 mm, Length 30 mm
1307-70-036	Non Locking Metaglène Screw Diameter 4.5 mm, Length 36 mm
1307-70-042	Non Locking Metaglène Screw Diameter 4.5 mm, Length 42 mm
1307-90-024	Locking Metaglène Screw Diameter 4.5 mm, Length 24 mm
1307-90-030	Locking Metaglène Screw Diameter 4.5 mm, Length 30 mm
1307-90-036	Locking Metaglène Screw Diameter 4.5 mm, Length 36 mm
1307-90-042	Locking Metaglène Screw Diameter 4.5 mm, Length 42 mm
1307-90-048	Locking Metaglène Screw Diameter 4.5 mm, Length 48 mm



REVISION IMPLANT CODES

Cemented Monobloc Humeral Implants Long

Cat No.	Description
1307-08-110	Cemented Monobloc Humeral Implant, Epiphysis Size 1, Diameter 8 mm, Long Length
1307-10-110	Cemented Monobloc Humeral Implant, Epiphysis Size 1, Diameter 10 mm, Long Length
1307-12-110	Cemented Monobloc Humeral Implant, Epiphysis Size 1, Diameter 12 mm, Long Length
1307-14-110	Cemented Monobloc Humeral Implant, Epiphysis Size 1, Diameter 14 mm, Long Length
1307-10-210	Cemented Monobloc Humeral Implant, Epiphysis Size 2, Diameter 10 mm, Long Length
1307-12-210	Cemented Monobloc Humeral Implant, Epiphysis Size 2, Diameter 12 mm, Long Length
1307-14-210	Cemented Monobloc Humeral Implant, Epiphysis Size 2, Diameter 14 mm, Long Length



Delta Xtend™ CTA heads

1307-48-021	Delta Xtend™ CTA Head Diameter 48 x 21 mm
1307-48-026	Delta Xtend™ CTA Head Diameter 48 x 26 mm
1307-52-021	Delta Xtend™ CTA Head Diameter 52 x 21 mm
1307-52-026	Delta Xtend™ CTA Head Diameter 52 x 26 mm



Ordering Information

Humeral Instruments

2307-99-901 Humeral Case 1 Base
 2307-99-922 Humeral Case 1 Lid

2307-99-905 Humeral Case 1 Top Tray

- 1 2128-61-070 Standard Hudson T-handle
- 2 1524-00-000 Hudson AO Converter
- 3 2128-01-006 Medulary Canal Reamer 6 mm
- 4 2128-01-008 Medulary Canal Reamer 8 mm
- 5 2128-01-010 Medulary Canal Reamer 10 mm
- 6 2128-01-012 Medulary Canal Reamer 12 mm
- 7 2128-01-014 Medulary Canal Reamer 14 mm
- 8 2128-01-016 Medulary Canal Reamer 16 mm
- 9 2001-65-000 Humeral Head Impactor
- 10 2001-66-000 Head Impactor Tip
- 11 2307-67-000 Humeral Cup Impactor Tip
- 12 2307-68-000 Spacer Impactor Tip

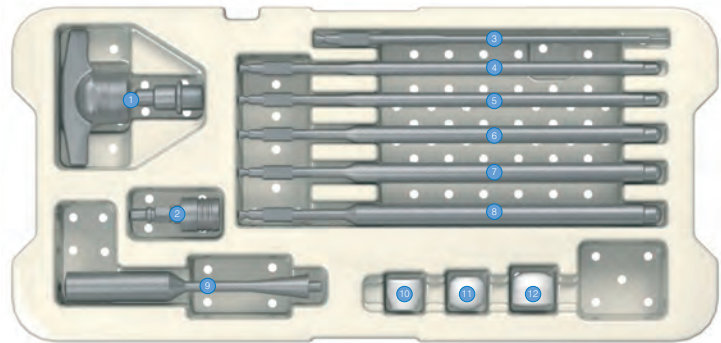

2307-99-924 Humeral Case 1 Middle Tray

- 1 2307-70-008 Handle for Cutting Guide 8 mm
- 2 2307-70-010 Handle for Cutting Guide 10 mm
- 3 2307-70-012 Handle for Cutting Guide 12 mm
- 4 2307-70-014 Handle for Cutting Guide 14 mm
- 5 2307-70-016 Handle for Cutting Guide 16 mm
- 6 2307-72-003 Delto-pectoral Cutting Guide
- 7 2307-72-004 Delto-pectoral Cutting Plate
- 8 2307-73-003 Superior-lateral Cutting Guide
- 9 2307-73-004 Superior-lateral Cutting Plate
- 10 2307-99-004 Pin Extractor
- 11 2307-71-000 Orientation Pin
- 12 9399-99-315 Drill Bit ø 3.2 mm
- 13 2490-95-000 Cutting Guide Fixation Pin ø 3.2 mm x 2
- 14 2490-95-000 Cutting Guide Fixation Pin ø 3.2 mm x 2

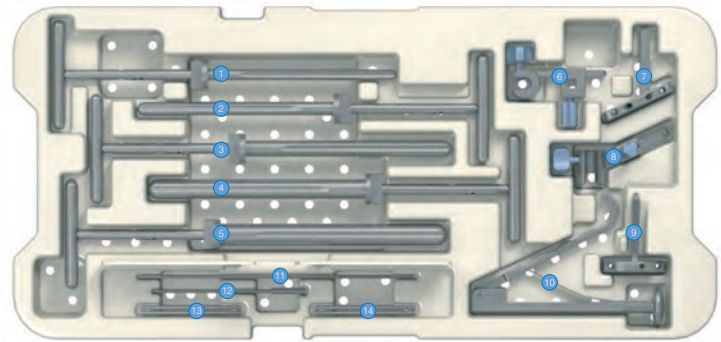

2307-99-923 Humeral Case 1 Bottom Tray

- 1 2307-74-008 Proximal Reaming Guide 8 mm
- 2 2307-74-010 Proximal Reaming Guide 10 mm
- 3 2307-74-012 Proximal Reaming Guide 12 mm
- 4 2307-74-014 Proximal Reaming Guide 14 mm
- 5 2307-74-016 Proximal Reaming Guide 16 mm
- 6 2307-83-000 Humeral Implant Driver
- 7 2307-85-000 Humeral Resection Protection Plate
- 8 2307-74-001 Proximal Reaming Guide Holder
- 9 2307-74-002 Proximal Reaming Guide Holder Internal Rod

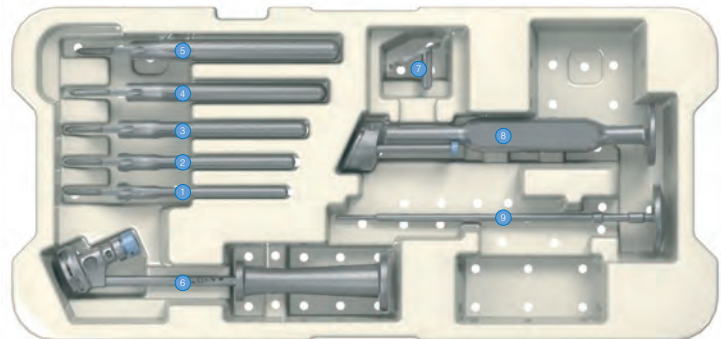

Ordering Information

Humeral Instruments

- 2307-99-906 Humeral Case 2 Base
- 2307-99-927 Humeral Case 2 Lid

2307-99-931 Humeral Case 2 Top Left Tray

- 1 2307-08-100 Monobloc Humeral Trial, Epiphysis Size 1, \varnothing 8 mm, Std
- 2 2307-10-100 Monobloc Humeral Trial, Epiphysis Size 1, \varnothing 10 mm, Std
- 3 2307-12-100 Monobloc Humeral Trial, Epiphysis Size 1, \varnothing 12 mm, Std
- 4 2307-14-100 Monobloc Humeral Trial, Epiphysis Size 1, \varnothing 14 mm, Std
- 5 2307-10-200 Monobloc Humeral Trial, Epiphysis Size 2, \varnothing 10 mm, Std
- 6 2307-12-200 Monobloc Humeral Trial, Epiphysis Size 2, \varnothing 12 mm, Std
- 7 2307-14-200 Monobloc Humeral Trial, Epiphysis Size 2, \varnothing 14 mm, Std

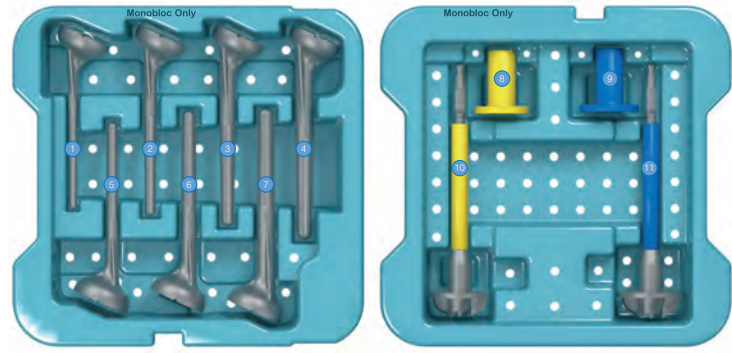

2307-99-932 Humeral Case 2 Top Right Tray

- 8 2307-80-003 Monobloc Epiphyseal Disk Size 1
- 9 2307-80-004 Monobloc Epiphyseal Disk Size 2
- 10 2307-81-003 Monobloc Proximal Reamer, Epiphysis Size 1
- 11 2307-81-004 Monobloc Proximal Reamer, Epiphysis Size 2

2307-99-909 Humeral Case 2 Middle Left Tray

- 1 2307-10-001 Modular Humeral Stem Trial \varnothing 10 mm
- 2 2307-12-001 Modular Humeral Stem Trial \varnothing 12 mm
- 3 2307-14-001 Modular Humeral Stem Trial \varnothing 14 mm
- 4 2307-16-001 Modular Humeral Stem Trial \varnothing 16 mm
- 5 2307-84-001 Modular Implant Locking Wrench \varnothing 10-12 mm
- 6 2307-84-002 Modular Implant Locking Wrench \varnothing 14-16 mm
- 7 2307-20-102 Modular Eccentric Trial Epiphysis Size 1 Left
- 8 2307-20-101 Modular Centred Trial Epiphysis Size 1
- 9 2307-20-103 Modular Eccentric Trial Epiphysis Size 1 Right
- 10 2307-20-202 Modular Eccentric Trial Epiphysis Size 2 Left
- 11 2307-20-201 Modular Centred Trial Epiphysis Size 2
- 12 2307-20-203 Modular Eccentric Trial Epiphysis Size 2 Right

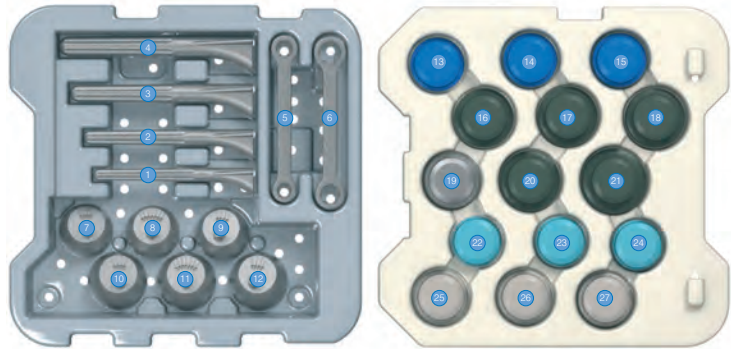

2307-99-910 Humeral Case 2 Middle Right Tray

- 13 2307-38-403 Standard Humeral Cup Trial \varnothing 38 mm +3 mm
- 14 2307-38-406 Standard Humeral Cup Trial \varnothing 38 mm +6 mm
- 15 2307-38-409 Standard Humeral Cup Trial \varnothing 38 mm +9 mm
- 16 2307-42-403 Standard Humeral Cup Trial \varnothing 42 mm +3 mm
- 17 2307-42-406 Standard Humeral Cup Trial \varnothing 42 mm +6 mm
- 18 2307-42-409 Standard Humeral Cup Trial \varnothing 42 mm +9 mm
- 19 2307-30-009 Humeral Spacer Trial +9 mm
- 20 2307-38-506 Retentive Humeral Cup Trial \varnothing 38 mm +6 mm
- 21 2307-42-506 Retentive Humeral Cup Trial \varnothing 42 mm +6 mm
- 22 2307-38-303 High Mobility Humeral Cup Trial \varnothing 38 mm +3 mm
- 23 2307-38-306 High Mobility Humeral Cup Trial \varnothing 38 mm +6 mm
- 24 2307-38-309 High Mobility Humeral Cup Trial \varnothing 38 mm +9 mm
- 25 2307-42-303 High Mobility Humeral Cup Trial \varnothing 42 mm +3 mm
- 26 2307-42-306 High Mobility Humeral Cup Trial \varnothing 42 mm +6 mm
- 27 2307-42-309 High Mobility Humeral Cup Trial \varnothing 42 mm +9 mm

2307-99-928 Humeral Case 2 Bottom Tray

- 1 2307-01-030 Broach Handle
- 2 2307-01-031 Goniometer
- 3 2307-79-010 Humeral Broach \varnothing 10 mm
- 4 2307-79-012 Humeral Broach \varnothing 12 mm
- 5 2307-79-014 Humeral Broach \varnothing 14 mm
- 6 2307-79-016 Humeral Broach \varnothing 16 mm
- 7 2307-01-032 Broach Handle Plate
- 8 2307-76-002 Eccentric Proximal Reaming Adaptor Size 2
- 9 2307-76-000 Centred Proximal Reaming Adaptor
- 10 2307-76-001 Eccentric Proximal Reaming Adaptor Size 1
- 11 2307-77-004 Epiphyseal Disk for Modular Implant Size 2
- 12 2307-77-003 Epiphyseal Disk for Modular Implant Size 1
- 13 2307-78-003 Proximal Reamer for Modular Implant Size 1
- 14 2307-78-004 Proximal Reamer for Modular Implant Size 2

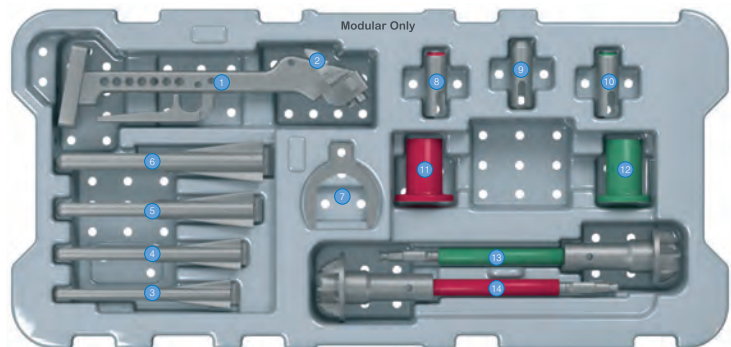

Ordering Information

Glenoid Instruments

- 2307-99-913 Glenoid Case Base
- 2307-99-934 Glenoid Case Lid

2307-99-936 Glenoid Case Top Tray

- 1 2307-86-002 Forked Retractor
- 2 2307-87-004 Metaglene Central Guide Pin \varnothing 2.5 mm x 2
- 3 2307-87-005 Metaglene Holder
- 4 2307-87-002 Metaglene Holder Internal Rod
- 5 2307-87-003 Metaglene Positioning Plate
- 6 2307-88-027 Glenoid Resurfacing Reamer \varnothing 27 mm
- 7 2307-88-242 Glenoid Manual Reamer \varnothing 42 mm
- 8 2307-88-300 Glenoid Reaming Level Checker
- 9 2307-89-000 Glenoid Cannulated Stop Drill \varnothing 7.5 mm

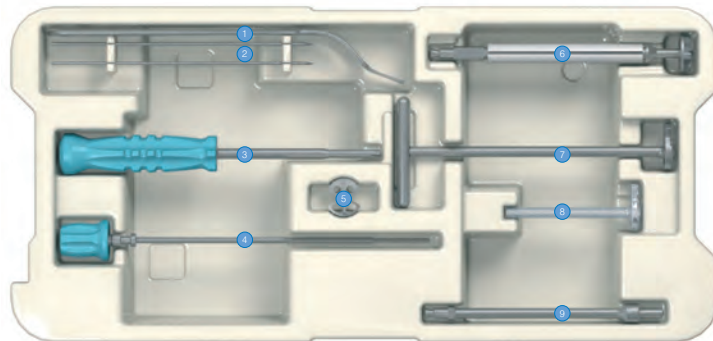

2307-99-935 Glenoid Case Bottom Tray

- 1 2307-90-005 Drill Bit \varnothing 2.5 mm Length 120 mm x 2
- 2 2307-90-004 Screw Guide Pin \varnothing 1.2 mm Length 150 mm x 5
- 3 2307-96-000 Glenosphere Guide Pin \varnothing 1.5 mm, Length 300 mm
- 4 2307-91-001 Screw Depth Gauge
- 5 2307-93-000 3.5 mm Cannulated Hex Screwdriver
- 6 2307-92-003 Locking Screwdriver
- 7 2307-92-004 Locking Screwdriver Internal Rod
- 8 2307-90-003 Glenoid Drill Guide \varnothing 2.5 mm
- 9 2307-60-038 Eccentric Glenosphere Trial \varnothing 38 mm
- 10 2307-60-138 Standard Glenosphere Trial \varnothing 38 mm
- 11 2307-99-002 Extraction T-handle
- 12 2307-60-042 Eccentric Glenosphere Trial \varnothing 42 mm
- 13 2307-60-142 Standard Glenosphere Trial \varnothing 42 mm
- 14 2307-95-000 Glenosphere Orientation Guide

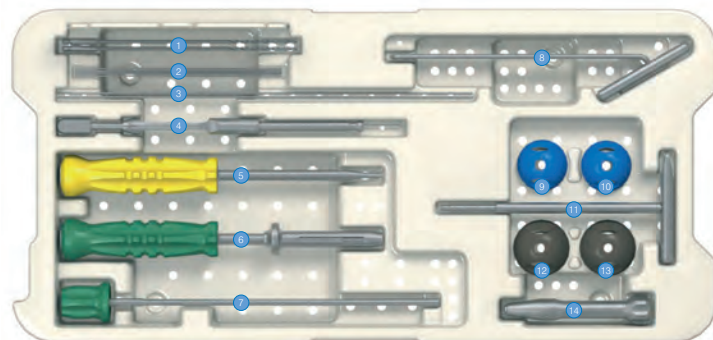

Ordering Information

Revision Instruments

2307-99-917 Revision Case Base
 2307-99-938 Revision Case Lid

2307-99-940 Revision Case Top Tray

- ① 2307-99-001 Humeral Cup Extraction Clamp
- ② ITH003 Stem Impactor/Extractor
- ③ 2307-82-001 Delta Xtend™ CTA Head Reamer Guide
- ④ 2307-82-003 Delta Xtend™ CTA Head Reamer
- ⑤ ETH001 Standard Humeral Prosthesis Extractor
- ⑥ MAI001 Slap Hammer
- ⑦ MDE001 Extraction Rod

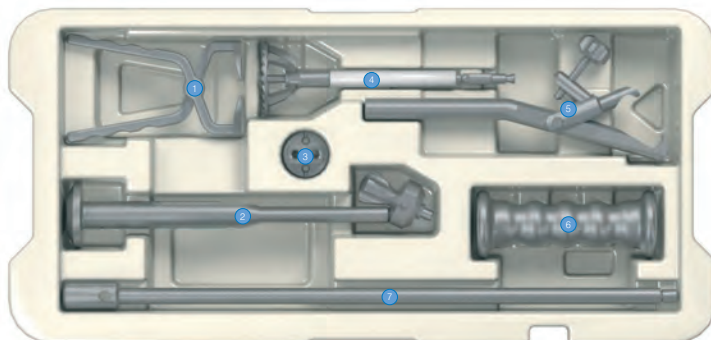

2307-99-939 Revision Case Bottom Tray

- ① 2307-08-110 Monobloc Humeral Trial, Epiphysis Size 1, 8 mm, Long
- ② 2307-10-110 Monobloc Humeral Trial, Epiphysis Size 1, 10 mm, Long
- ③ 2307-12-110 Monobloc Humeral Trial, Epiphysis Size 1, 12 mm, Long
- ④ 2307-14-110 Monobloc Humeral Trial, Epiphysis Size 1, 14 mm, Long
- ⑤ 2307-10-210 Monobloc Humeral Trial, Epiphysis Size 2, 10 mm, Long
- ⑥ 2307-12-210 Monobloc Humeral Trial, Epiphysis Size 2, 12 mm, Long
- ⑦ 2307-14-210 Monobloc Humeral Trial, Epiphysis Size 2, 14 mm, Long
- ⑧ 2307-48-121 Delta Xtend™ CTA Trial Head ø 48 mm x 21 mm
- ⑨ 2307-48-126 Delta Xtend™ CTA Trial Head ø 48 mm x 26 mm
- ⑩ 2307-52-121 Delta Xtend™ CTA Trial Head ø 52 mm x 21 mm
- ⑪ 2307-52-126 Delta Xtend™ CTA Trial Head ø 52 mm x 26 mm
- ⑫ 2128-01-035 Global® FX Positioning Jig

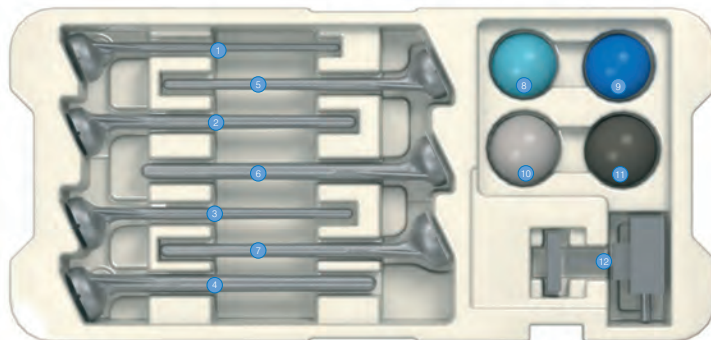



Delta Xtend™ Reverse Shoulder System

Important

This Essential Product Information sheet does not include all the information necessary for the selection and use of a device. Please see full labelling for all necessary information.

Intended Use / Indications

This Delta Xtend™ Reverse Shoulder System prosthesis is indicated for use in:

- Grossly rotator cuff deficient joint with severe arthropathy or a previously failed joint replacement with a grossly rotator cuff deficient joint.
- The patient's joint must be anatomically and structurally suited to receive the selected implant(s), and a functional Deltoid muscle is necessary to use the device. In cases of bone defects in the proximal humerus, the monobloc implant only should be used and then only in cases where the residual bone permits firm fixation of this implant.

Cementless or Cemented Components

The HA coated components are intended for cementless application and must not be implanted with cement. The monobloc humeral implants are intended for cemented use only.

Contraindications

Joint replacements may be contraindicated where the patient is overweight, where there is infection, poor bone stock, severe deformity, drug abuse, overactivity, tumor, mental incapacity, muscle, nerve or vascular disease.

Caution

The following conditions singularly or concurrently, tend to adversely affect the fixation of the shoulder replacement implants: marked osteoporosis or poor bone stock, metabolic disorders or systemic pharmacological treatments leading to progressive deterioration of solid bone support for the implant (e.g., diabetes mellitus, steroid therapies, immunosuppressive therapies, etc.), history of general or local infections, severe deformities leading to impaired fixation or improper positioning of the implant, tumours of the supporting bone structures, allergic reactions to implant materials (e.g. bone cement, metal, polyethylene), tissue reactions to implant corrosion or implant wear debris, disabilities of other joints.

Warnings and Precautions

Implants and trial components from different manufacturers or implant systems should never be used together.

Delta Xtend™ Reverse Shoulder System implants should never be used with the Delta CTA™ Reverse Shoulder implants.

Shoulder prosthesis components should never be re-implanted. Even though the implant appears undamaged, the implant may have developed microscopic imperfections, which could lead to failure.

Always use a trial prosthesis for trial purposes. Trials should not be assembled with any components intended for permanent implantation. Trials must have the same configuration size, etc., as the corresponding components to be implanted.

Do not alter or modify implants in any way.

Adverse Events and Complications

The following are generally the most frequently encountered adverse events and complications in total shoulder or hemi-shoulder arthroplasty: change in position of the prosthesis, early or late infection, early or late loosening of the prosthetic component(s), cardiovascular disorders including venous thrombosis, pulmonary embolism and myocardial infarction, hematoma and/or delayed wound healing, pneumonia and/or atelectasis, subluxation or dislocation of the replaced joint.

References

1. Neer CS 2nd, Craig EV, Fukuda H. Cuff-Tear Arthropathy. *J Bone Joint Surg* 1983; 65-A: 1232-1244.
2. Broström LA, Wallensten R, Olsson E, Anderson D. The Kessel prosthesis in total shoulder arthroplasty. A five year experience. *Clin Orthop* 1992; 277:155-60.
3. Grammont PM, Baulot E. Delta shoulder prosthesis for rotator cuff rupture. *Orthopaedics* 1993; 16: 65-8.
4. Sirveaux F, Favard L, Oudet D, Huguet D, Walch G, Molé D. Grammont inverted total shoulder arthroplasty in the treatment of glenohumeral osteoarthritis with massive rupture of the cuff. Results of a multicentre study of 80 shoulders. *J Bone Joint Surg Br* 2004; 86B: 388-395.
5. De Wilde LF, Audenaert EA, Bergs BM. Shoulder prosthesis treating cuff tear arthropathy : a comparative biomechanical study. *J. Orthop Research* 2004; 22:1222-1230.
6. Boileau P, Watkinson DJ, Hatzidakis AM, Balg F. Grammont reverse prosthesis : Design rationale and biomechanics. *J. Shoulder Elbow Surg* 2005; 14: 147-161.
7. Nyfeller RW, Werner CLM, Gerber C. Biomechanical relevance of glenoid component positioning in the Reverse Delta III prosthesis. *J. Shoulder Elbow Surg.* 2005; 14(5): 524-528.
8. Middernacht BO, De Roo PJ, Van Maele G, De Wilde LF. Anatomy of the glenoid : consequences for design and implantation of the base plate of the reverse prosthesis. In preparation.
9. Head WC, Bauk DJ, Emerson RH Jr. Titanium alloy as a material of choice for cementless femoral components in total hip arthroplasty. *Clin Orthop.* 1995; 311: 85-90.
10. Wirth MA, Lim MS, Southworth C, Lored R, Kaar TK, Rockwood CA Jr. Compaction bone-grafting in prosthetic shoulder arthroplasty. *J Bone Joint Surg* 2007; 89-A: 50-57.
11. Karelse A MD, Bhatia D, De Wilde LF. Prosthetic component relationship of the reversed Delta III total shoulder prosthesis in the transverse plane of the body. Accepted by *J Shoulder Elbow Surg* March 2007.
12. Collis D, Mohler G. Comparison of clinical outcomes in total hip arthroplasty using rough and polished cemented stems with essentially the same geometry. *J Bone Joint Surg* 2002; 84-A: 586-592.
13. Data on file, DePuy France, 2006.
14. De Wilde F, Plasschaert FS, Audenaert EA, Verdonk RC. Functional recovery after a reverse prosthesis for reconstruction of the proximal humerus in tumor surgery. *Clin Orthop.* 2005; 430: 156-62.
15. Van Seymourtier P, Stoffelen D, Fortems Y, Reynders P. The reverse shoulder prosthesis (Delta III) in acute shoulder fractures: technical considerations with respect to stability. *Acta Orthop Belg.* 2006; 72(4): 474-7.
16. Fenlin JM Jr. Total glenohumeral joint replacement. *Orthop Clin North Am* 1975; 6: 565-83.

This publication is not intended for distribution in the USA.

Cemvac® and CMW® are registered trademarks of DePuy International Ltd.
Delta CTA™ and Delta Xtend™ are trademarks and SmartSet®, Global® and Global® FX are registered trademarks of DePuy Orthopaedics, Inc.
© 2007 DePuy International Limited. All rights reserved.

Cat No: 9072-78-065 version 1



DePuy International Ltd
St Anthony's Road
Leeds LS11 8DT
England
Tel: +44 (113) 387 7800
Fax: +44 (113) 387 7890



DePuy France S.A.S.
7 allée Irène Joliot Curie
69800 Saint Priest
France
Téléphone: +33 (0)4 72 79 27 27
Télécopie: +33 (0)4 72 79 28 28

